



RPMME

Homepage: <http://penerbit.uthm.edu.my/periodicals/index.php/rpmme>
e-ISSN : 2773 - 4765

Portable Hand Driven Natural Rubber Roller Sheet and Crepe Machine

Bryan Louis Rumes¹, Sia Chee Kiong^{1,*}

¹Faculty of Mechanical and Manufacturing Engineering,
Universiti Tun Hussein Onn Malaysia, Parit Raja, Batu Pahat, Johor, 86400,
MALAYSIA

*Corresponding Author Designation

DOI: <https://doi.org/10.30880/rpmme.2023.04.02.050>

Received 01 July 2023; Accepted 01 Nov 2023; Available online 15 December 2023

Abstract: Natural rubber has been increasingly used in a wide range of applications, allowing it to be used on a broader range of things. Malaysia is one of the top ten producers of natural rubber in the world, making it an important source of income for the natural rubber industry, particularly for small-scale farmers. Most small-scale farmers struggled to process their latex due to uneconomic farm size, the age factor, and financial issues in their production. To address these issues, a Portable Hand Driven Natural Rubber Roller Sheet and Crepe Machine that can be operated at home or in rural areas has been designed to reduce costs and energy consumption while increasing production efficiency. This project uses the George E Dieter design process, which consists of eight phases (define problem, gather information, concept generation, concept evaluation, product architecture, configuration design, parametric design and detail) to create the machine. To generate ideas and concepts for the machine, the existing patent and available machines on the market were referred to. Next, the idea and concept generated will be modelled using SolidWorks software. SolidWork Software is also being used to conduct some engineering analysis and sustainability analysis for this machine. With the results of engineering calculations, engineering simulations, and analysis by SolidWork Software, the final concept and design can be made. The overall dimension of the Portable Hand Driven Natural Rubber Roller Sheet and Crepe Machine is 689mm x 493mm x 895mm with weight of 158.8kg

Keywords: Portable Hand Driven Natural Rubber Roller Sheet and Crepe Machine, Natural Rubber, George E Dieter design process, Solidwork

1. Introduction

Natural rubber has been more widely utilized in a wide range of applications, permitting it to be utilized on a more extensive range of things. For many years, this engineering fabric has been successfully used in the production of tires, building materials, and street construction materials. In the process of forming a rubber sheet, it required a press tool, which is also known as a rubber roller

* Corresponding author: sia@uthm.edu.my

2023 UTHM Publisher. All right reserved.

penerbit.uthm.edu.my/periodicals/index.php/rpmme

machine, to reduce the water content contained in the sheet rubber. According to the story written in *Panjang Jalan Pulang's* Blogspot [1], there are two types of manual natural rubber roller grinder machines, which are the smooth surface machine and the flower (groove line) surface machine. The majority of rubber smallholders have uneconomic farm sizes, low productivity due to aging, and limited financial access [2, 3, 4]. Therefore, the objective of this project is to design a low-cost, dependable, and long-lasting portable hand-driven natural rubber roller sheet and crepe machine that can be used at home or in rural areas using SolidWorks' topology optimization, static stress, and material sustainability simulations. The significance of this project is to design a functional, economical, and affordable machine that can be used by small-scale farmers. This project will also help small farmers produce their rubber sheet and crepe with ease and anywhere, thus increasing their income in the natural rubber industry.

1.1 Literature Review

The journey of natural rubber processing started with latex acknowledgment, latex dilution, latex freezing, milling, and finally, drying [5]. Between all these processes, the machine will be used in the milling process. At the end of the process, the latex sheet usually has a roughly rectangular shape, about 100 cm x 50 cm, with rounded corners and weighing rather more than 1 kilogram [6]. The mechanism in milling that would be used is the two-roll mill process, accompanied by a spur gear system as its power transfer mechanism. Furthermore, the existing patents and market products will be used as a reference to identify the strengths and weaknesses of the current existing machine, which will help greatly in generating an ideal Product Design Specification (PDS) in design creation.

2. Methodology

The plan interaction model from George E. Calorie Counter will be used to direct the project. As per the plan interaction model counter [7], the planned interaction for this project comprises three stages and eight steps, which are a conceptual design, an embodiment design, and a detailed design.

2.1 Conceptual Design

The primary stage in the conceptual design is the problem statement, where the issues faced by the small-scale farmer will be identified. Following that, using the patents and benchmarking strategy, the thought or answer for meeting the needs of the rubber smallholder will be completed. Then, at that point, a product design specification (PDS) will be created as a diagram for the product's plan and directed to design creation. The following stage is to gather information, and this stage is essential before proceeding with additional steps in the design process. Data can be acquired from a wide range of sources, either online or disconnected. The next analysis in conceptual design is concept generation, where all ideas will be collected to find the best solution to solve the problem. This step consists of four steps: component decomposition analysis, functional decomposition analysis, function structure, and morphological chart. After that, multiple choices of concepts will be generated and assessed using the weighted rating method to choose the best concept design for the machine.

2.2 Embodiment Design

The second phase of the planning cycle is embodiment design. Embodiment design is the stage at which structure improvement happens. During the design process, decisions on strength, material choice, size, structure, and space similarity are taken. Thus, the embodiment design for the project will be stressed based on the analysis of the shaft, gear, roller, and bearing. This analysis is critical to ensuring that the project's requirements for each component are met. The equation and formula used are shown in Table 1 below.

Table 1: Equation and formula used for analysis

Type of analysis	Equation or formula
Gear ratio, number of gear teeth analysis and contact ratio analysis	$M_{Go} = \frac{T_{out}}{T_{in}}$ $N_p = \frac{2k}{(1 + 2 M_G) \sin^2 \phi} \left(M_G + \sqrt{M_G^2 (1 + 2 M_G) \sin^2 \phi} \right)$ $CR = \frac{\sqrt{r_{a1}^2 - r_{b1}^2}}{P_c \cos \theta} + \frac{\sqrt{r_{a2}^2 - r_{b2}^2}}{P_c \cos \theta} - \frac{CD \sin \theta}{P_c \cos \theta}$
Shaft analysis (Criteria DE-Goodman),	$d = \left(\frac{16n}{\pi} \left\{ \frac{1}{S_e} [4(K_f M_a)^2]^{1/2} + \frac{1}{S_{ut}} [3(K_{fs} T_m)^2]^{1/2} \right\} \right)^{1/3}$
Bearing analysis	$F_D = \sqrt{F_y^2 + F_z^2}$ $C_{10} = a_f F_D \left[\frac{60 L_D n_D}{60 L_R n_R} \right]^{1/a} = a_f F_D \left[\frac{60 L_D n_D}{10^6} \right]^{1/a}$

2.3 Detail Design

The detailed design is the finished specification of the geometry, materials, and tolerances of all the parts of the machine and is provided by detailed drawings, assembly drawings, and general assembly drawings using SolidWorks software. Results like 2D and 3D models, topology optimization, static stress analysis, and sustainability analysis will be utilized in the comprehensive design.

3. Results and Discussion

3.1 Result of Conceptual Design phase

As per discussed in methodology, the conceptual design phase was the starting point to generate an ideal concept design for the machine. The selected concept was based on the logical judgment and various information such as problem statement, objective, PDS etc. Thus, the result of the analysis is shown in Figure and Table below.

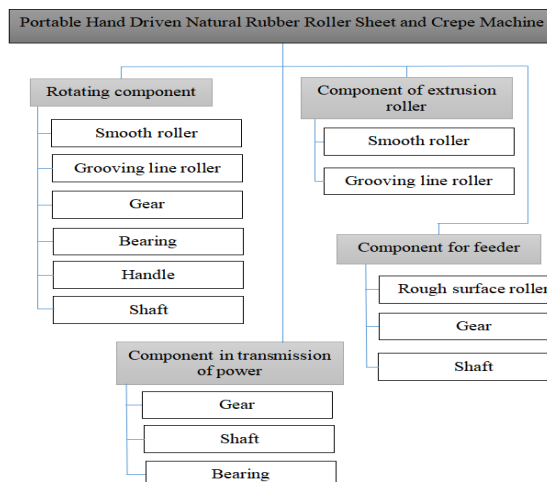

Figure 1: Component Decomposition Analysis

Table 2: Functional Decomposition Analysis

No	Component	Function
1	Handle	To move the rotating component in circular motion
2	Gear	Transfer the power and movement to another component. To control the speed of the rotating component
3	Smooth roller, Grooving line roller	To extrude the material passing through it
4	Rough surface roller	To move the material into the mouth of the roller
5	Bearing	To smooth the rotation of shaft and roller Hold the position of shaft
6	Shaft	To move the roller and gear Act as a connection between roller and gear
7	Feeder	Hold the material before its moving into the mouth of roller
8	Housing	To cover the component of machine from external environment
9	Bolt and screw	To combine the component in machine

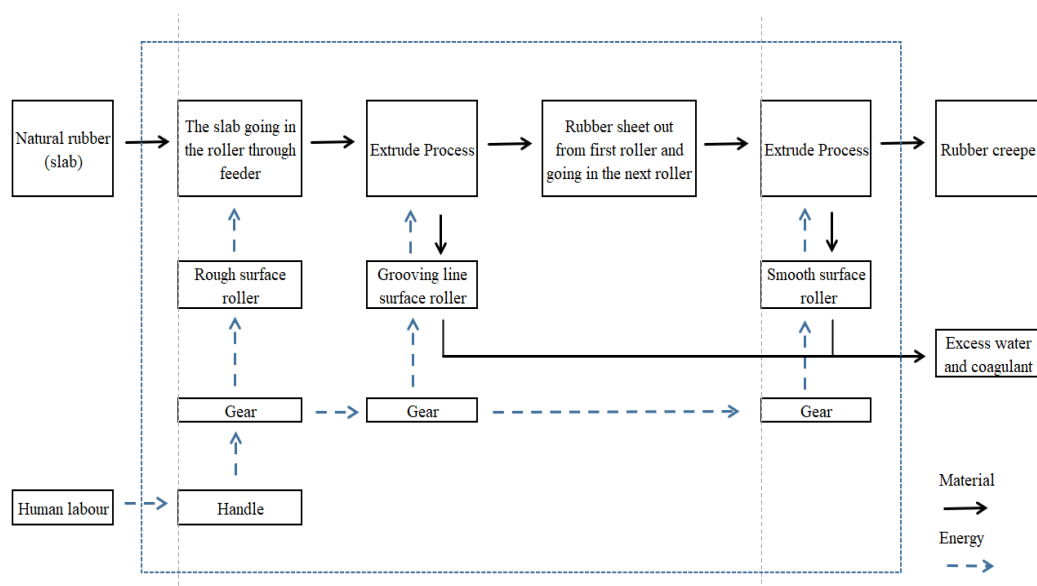
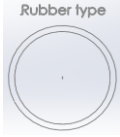
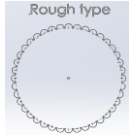
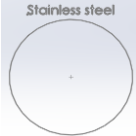
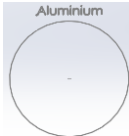
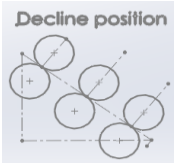
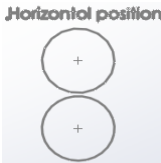
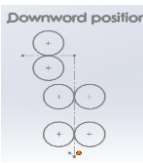

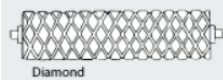
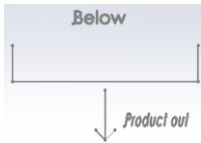
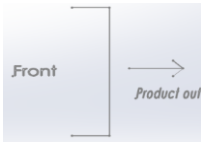
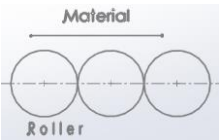
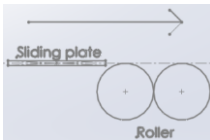

Figure 2: Function Structure

Table 3: Morphological Chart

Function	Concept		
	1	2	3
Type of roller surface (material into mouth roller)	[2, 3] 	[1] 	-
Type of roller use to extrude the slab into rubber sheet	[2, 3] 	[1] 	-
Position of extruded roller	[3] 	[2] 	[1] 
Type of grooving line roller	[2] 	[3] 	[1] 
Location for outlet	[3] 	[1, 2] 	-
The design of the feeder	[2, 3] 	[1] 	-
No of extrude roller	[2] 1 set of grooving line surface roller, 1 set of smooth surface roller	[1] 2 set of grooving line surface roller, 1 set of smooth surface roller	[3] 2 set of grooving line surface roller, 2 set of smooth surface roller

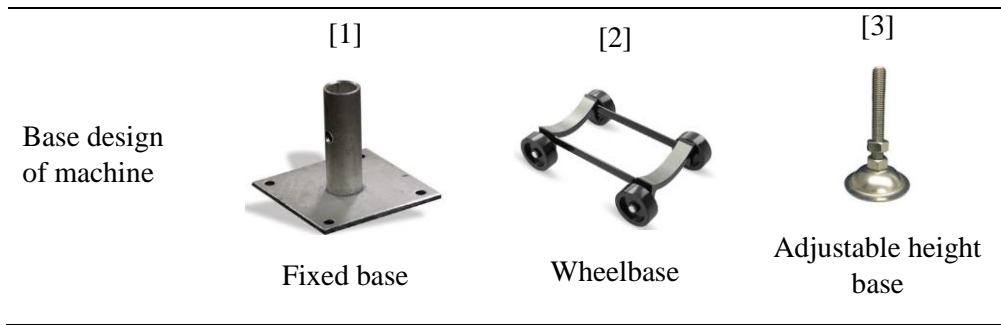
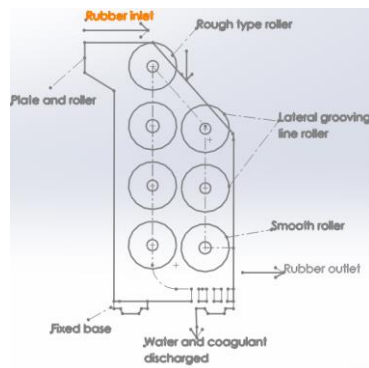

Table 4: Weighted Rating Method

Criteria	Weight factor	1		2		3	
		S	R	S	R	S	R
Characteristic							
Easy to use	0.09	4	0.36	4	0.36	4	0.36
Require 1 person to operate	0.09	5	0.45	5	0.45	4	0.36
Portable	0.07	4	0.28	5	0.35	3	0.21
Cost							
Low maintenance cost	0.09	4	0.36	4	0.36	3	0.27
Low component cost	0.09	4	0.36	4	0.36	3	0.27
Design							
Durable	0.09	4	0.36	3	0.27	3	0.27
Medium weight	0.07	4	0.28	4	0.28	3	0.21
Quality							
Durable	0.09	4	0.36	3	0.27	3	0.27
Long life term	0.08	4	0.32	3	0.24	3	0.24
Ergonomic							
Safe to use	0.09	4	0.36	4	0.36	4	0.36
Stable	0.07	5	0.35	4	0.28	3	0.21
Easy to clean	0.08	4	0.32	4	0.32	3	0.24
Total	1.00	4.16		3.90		3.27	



Concept 1	
Type of roller surface	Rough type
Type of roller use to extrude the slab into rubber sheet	Aluminium
Position of extruded roller	Downward
Type of grooving line roller	Lateral
Location for outlet	Front
The design of the feeder	Slider and roller
Number of extrude roller	2 set of grooving line surface roller, 1 set of smooth surface roller
Base design of machine	Fixed base

Figure 3: Selected concept design and summaries

From the result of Figure and Table above, Concept 1 has the highest rating level, followed by Concept 2 and Concept 3. So, Concept 1 was chosen as the concept that will be used in the design of this Portable Hand Driven Natural Rubber Roller Sheet and Crepe Machine. Concept 1 involves using a rough surface roller, which makes it easier to transport the material without any slippage during operation. Concept 1 uses aluminium as the material of the extruder roller. Aluminum has good corrosion resistance and is cheap and lightweight compared to stainless steel. Furthermore, Concept 1 uses the least amount of roller, saving space and reducing the machine's size and weight. It also helps in reducing any possibility of producing noise for the machine. The roller is enough to carry out its function as an extruder for this project. Lastly, using a fixed base will provide enough support and stability for the machine.

3.2 Result of Embodiment Design phase

By using the given equation and formula in previous subtopic 2.2, the analysis of the shaft, gear, and bearing can be calculated. This result was necessary to obtain the suitable force, torque and dimension required when designing the machine. The result for gear, shaft, bearing is shown as in Table 5 to 9 below.

Table 5: Torque and RPM

	n (RPM)	T (Nm)	N (no of teeth)
Handle	-	200	-
Gear 1,5,8	15	200	15
Gear 2,3,4,6,7	5	600	45
Gear 5	15	200	15
Gear 6,7	5	600	45
Gear 8	15	200	15
Gear 9,10	10	525.211	45

Table 6: Detail selection for each gear based on KHK catalogue

Gear	Module	Type	No. Catalogue	N (Teeth)	Diameter pitch, D_p (mm)	Gear face width, F (mm)	Bore diameter (mm)
1,5,8	3	Ground Spur Gear	MSGA3-15	15	45	30	18
2,3,4,6,7			MSGA3-45	45	135	30	30
9,10			MSGA3-45	45	135	30	30

Table 7: Contact Ratio of each gear set

Gear set	Contact Ratio
1,4, 7	1.61
2, 5, 8	1.73
3, 6	1.61

Table 8: Result for shaft analysis

	Shaft 1, 5, 8	Shaft 2, 3, 4, 6, 7	Shaft 9, 10
d (mm)	30	30	30
D (mm)	33	35	34
D/d	1.1	1.2	1.1
$r = d/10$ (mm)	3	3	3
r/d	0.1	0.1	0.1
q	0.83	0.83	0.83
K_t	1.6	1.62	1.6
q_s	0.88	0.88	0.88
K_{ts}	1.23	1.26	1.23
K_f	1.498	1.5146	1.498
K_{fs}	1.2024	1.2288	1.2024
K_a	0.817	0.817	0.817
K_b	0.864	0.864	0.864

Se (MPa)	194.9	194.9	194.9
σ'_a (MPa)	0.105	0.106	0.091
σ'_m (MPa)	0.052	0.054	0.046
n_f	1609.5	1588.3	1852.1
n_y	3375.7	3312.5	3.868.6

Table 9: Bearing analysis

	Bearing				
	A, H, M	B, D, F, I, K	C, E, G, J, L	N	O
F _Y (N)	177.8	8619.5	269.4	7545.1	235.8
F _Z (N)	64.7	3137.2	98.1	2746.2	85.8
F _D (N)	189.2	9170.8	286.7	8029.3	250.9
n_d (RPM)	15	5	5	10	10
C ₁₀ (N)	209.1	7027.7	219.7	7752.2	242.2
C ₁₀ (kN)	0.2	7.02	0.2	7.8	0.2

Table 10: Bearing selection

	Bearing				
	A, H, M	B, D, F, I, K	C, E, G, J, L	N	O
Load Rating (kN)	5.45	13.50	5.45	13.50	5.45
Bore, mm	35	40	35	40	35
OD, mm	47	62	47	62	47
Width, mm	7	12	7	12	7

3.3 Result of Detail Design phase

For this phase, all the finished specifications of the geometry, materials, and tolerances of all the parts of the machine was provided by detailed drawings. Other analysis such as topology optimization, static stress analysis, and sustainability analysis will also be done using SolidWork software. The result was shown in Figure 4 to 8 below.

Figure 4: Detail drawing and engineering number for each component for Portable Hand Driven Natural Rubber Roller Sheet and Crepe Machine

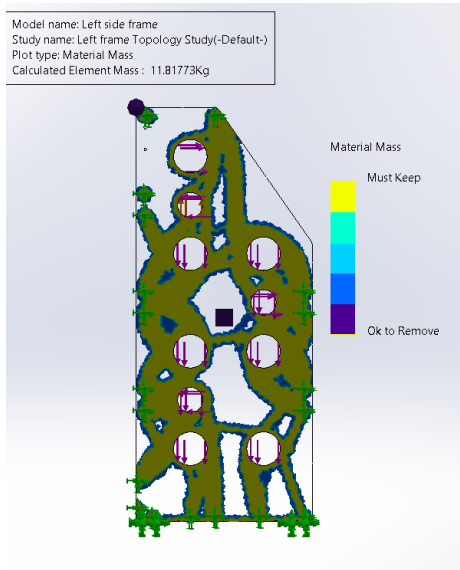
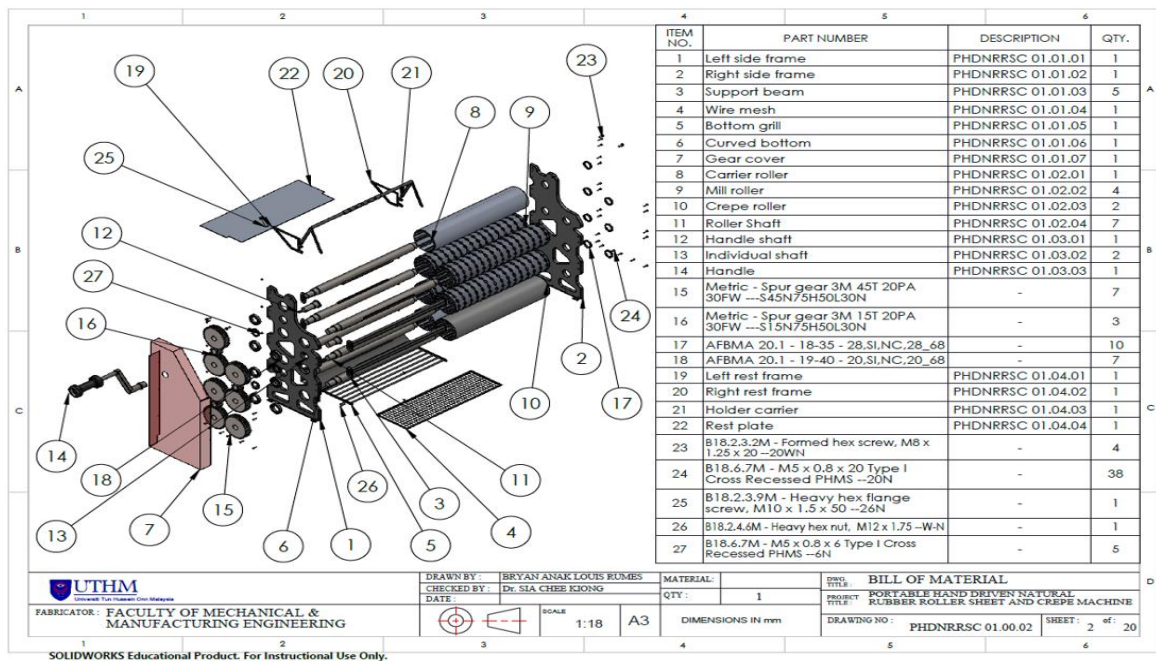

Figure 5: Result of the Topology Optimization for left side frame

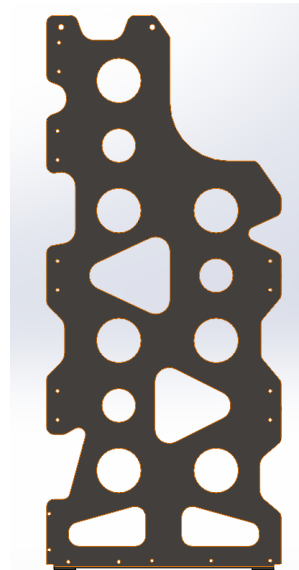

Figure 6: Final design of the left frame

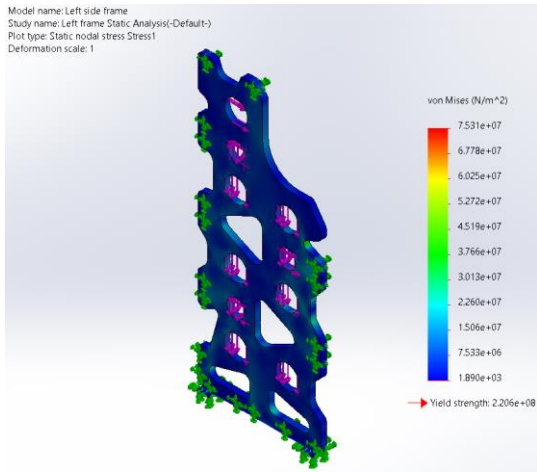

Figure 7: Result of stress analysis on left frame

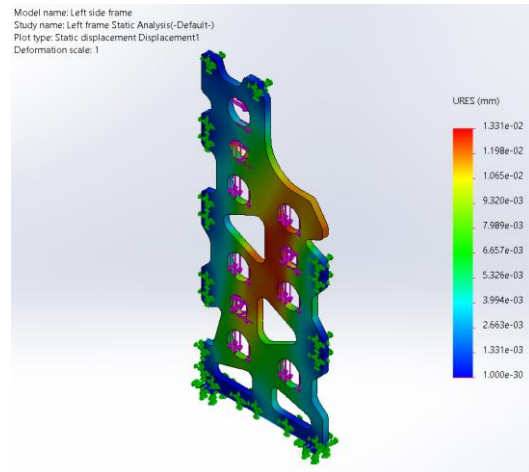

Figure 8: Result of displacement analysis on left frame

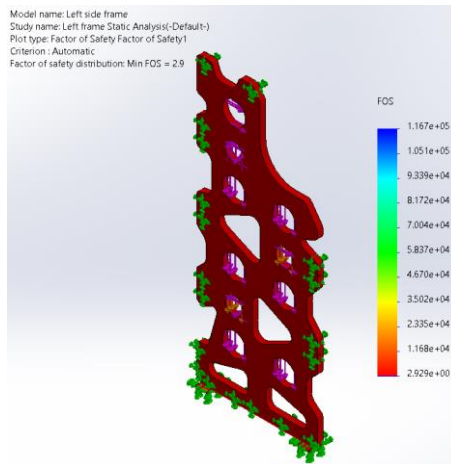

Figure 9: Result of Safety factor of left frame

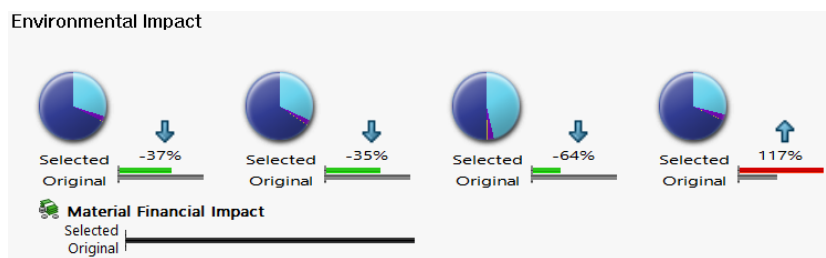

Figure 10: Result environmental impact between Alloy Steel and Aluminium 1060 Alloy

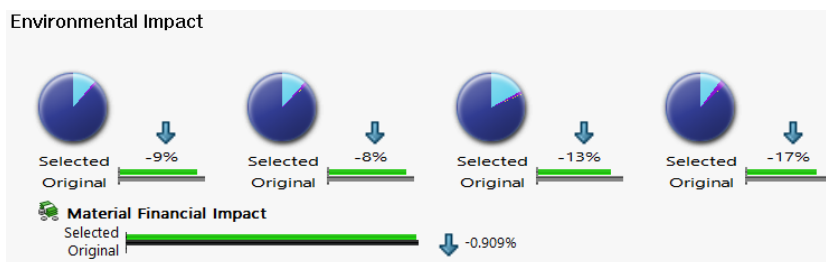

Figure 11: Result environmental impact between Aluminium 3003 Alloy and Aluminium 1060 Alloy

For topology optimization, this analysis was used to reduce the weight of the frame of the machine while maintaining its strength. The left frame was considered one of the most important components of the machine since a much larger force will be focused in that area. Since the torque applied is greater than the weight of the other component of the machine, the force that was calculated in shaft analysis will be used as the restriction parameter for this part. During the analysis, the total weight reduction from the original weight was 50%. The above result shows how much area can be reduced and maintained so that the frame can maintain its strength to withstand the torque applied while reducing the weight from 23.4 kg to 11.8 kg. As a result, the new frame design considered other factors such as stability and shaft position, as shown in Figure 6.

While for the static analysis, a detailed study carried out on a left side frame to identify the ability of a component to function safely under subjected stress. From the result of the static analysis in Figure 7 to 9, the left frame will not fail or bend since the resultant stress shown by the Von Mises stress does not exceed the value of the yield strength of the material, which is 220.6 MPa. As for the result of load induced displacement analysis, the maximum displacement is $1.331 \times 10^{-3} mm$, which will not affect the performance of the component. The result of factor safety for the left frame also shows a minimum value of 2.9, which is considered safe in standard industry.

Finally, for sustainability analysis, the chosen material for the roller mill is crucial since this component will be in direct contact with the processing material (natural rubber). As a result, it is critical to choose appropriate materials for the roller mill so that the produced and waste materials do not harm natural rubber or the environment. It should be noted that the tensile and yield strengths of these two new materials are higher than the original. From result of analysis in Figure 10, Alloy Steel has a greater significant impact on reducing the environmental impact of carbon, energy, and air, according to the findings. However, this trend changes when it comes to the environmental impact on water, where it shows a higher increase in pollution compared to the original material. Thus, Alloy Steel cannot be used for the roller mill component. While for the result of analysis in Figure 11, Aluminum Alloy 3003, on the other hand, exhibits change in terms of reducing environmental impact, though it is far less than Alloy Steel. It is reducing the environmental impact in all aspects, including carbon, energy, air, and water. As a result, Aluminium Alloy 3003 is appropriate for roller mill components because it has a low environmental impact in all aspects.

4. Conclusion

In a nutshell, the design for the Portable Hand Driven Natural Rubber Roller Sheet and Crepe Machine was successfully completed according to the engineering design process introduced by Goerge E. Dieter. The required calculations and analyses based on the course of mechanical engineering were also successfully applied during the design of this machine. With aid from the latest design software, such as Solidworks, the design of the machine can be fully developed with an excellent simulation video, which greatly helps us understand more about the process and concept of the machine.

Furthermore, the objective of the project was also achieved because the machine can utilise two types of processes: turning the natural rubber slab into natural rubber sheet and natural rubber creep. The installation of the machine is also convenient since it only uses bolts, nuts, and screws. These features will greatly assist small-scale farmers in reducing time, energy consumption, and costs. The machine's design also makes it suitable for use at home or in rural areas. Lastly, the machine can also be operated using human force, which is a huge advantage for small-scale farmers who work in rural areas.

Even though the machine's design is complete, the concept is still in the prototype stage, with the possibility of failure or defect. Thus, the machine's design can still be improved in the future. There are a few recommendations for this machine, such as:

1. Improve the design between the handle and shaft of the machine so the tip of the shaft can be mounted with another electrical device, such as a hand drill, to replace the power source of the handle.
2. Improve the roller's design so that its features can be combined into one to reduce space and reduce the machine's size.
3. Further research about the power and torque of the cylinder roller and the natural rubber properties is needed, where this information can greatly help in calculating the required power and torque for the process as well as in designing the machine.

Acknowledgement

The authors wish to thank to the Faculty of Mechanical and Manufacturing Engineering, Universiti Tun Hussein Onn Malaysia that has supported on the accomplishment of research activity.

References

- [1] Nostalgia GETAH..... NOSTALGIA GETAH..... (2009, February 10). Retrieved June 12, 2022, from <http://surl.li/ciume>
- [2] Hussin, F., & Abdullah, H. (2012). The Role of FELDA and KESEDAR in the Development of Land in the District of Gua Musang: A Comparison the Socio-Economic Level of the Settlers. *Sustainable Agriculture Research*, 1(2), 284. <https://doi.org/10.5539/sar.v1n2p284>
- [3] Manivong, V. (2007). The economic potential for smallholder rubber production in Northern Laos (pp. 1-245). Brisbane: University of Queensland. Retrieved June 13, 2022, from <http://lad.nafri.org.la/fulltext/LAD010320080112.pdf>
- [4] Ng, J., & Hamdan, M. A. H. (2020, September 10). Cover story: The plight of Malaysia's rubber smallholders. *The Edge Markets*. Retrieved June 13, 2022, from <http://surl.li/ciult>
- [5] EL MAS'UDY, M. C. (2018). RANCANG BANGUN MESIN PENGILING KARET (Crumb Rubber Kubota) SKALA LABOR (Doctoral dissertation, Universitas Pasir Pengaraian Kabupaten) from <http://surl.li/ciune>
- [6] Cecil, J. C., & Mitchell, P. M. (2005). Processing of Natural Rubber. *Earticle*. Retrieved June 13, 2022, from <http://surl.li/ciugw>
- [7] Dieter, G. E., & Schmidt, L. C. (2009). *Engineering design* (Vol. 4). Boston: McGraw-Hill Higher Education from <https://rb.gy/kjgooa>