

Experimental Study of Soil Resistivity Using Different Rod Design and Material for Grounding System

M. A. A. Mahadi¹, N. A. Othman^{1*}, N. A. M. Jamail¹, Z. Adzis²

¹Department of Electrical Engineering, Faculty of Electrical & Electronic Engineering,
Universiti Tun Hussein Onn Malaysia, 86400 Batu Pahat, MALAYSIA

²School of Electrical Engineering, Faculty of Engineering,
Universiti Teknologi Malaysia, 81310 Johor Bahru, Johor, MALAYSIA

DOI: <https://doi.org/10.30880/eeee.2020.01.01.008>

Received 03 August 2020; Accepted 06 September 2020; Available online 30 October 2020

Abstract: Grounding system is the most crucial area in power system network. Poor grounding system can be dangerous to the users and wire of the electrical distribution system in the event of electrical fault. To prevent this accident, it is very important to have a good grounding system to protect the system as well as to the user. Therefore, this paper measures the soil resistivity with various planted electrode designs using Wenner Four Point method with the help of equipment earth testers. The experimental works was conducted in clay soil type using copper and iron rod materials. The experimental results show that the new rod design with branches can be considered not suitable to replace the standard rod since the measured soil resistivity was much higher. It is also proven that the copper rod exhibits better value of soil resistivity which can be used for the grounding system.

Keywords: Grounding, Soil Resistivity, Wenner Four Point Method, Copper, Iron

1. Introduction

Grounding systems play a crucial role in power system network protection especially during abnormal conditions since it is a fundamental part of the electrical system. Electrical system consists of large equipment with high cost that require high protection systems. The primary purpose of grounding is to provide a common reference point for electrical safety mechanisms for both people and equipment [1] as well as to minimize potential overvoltage.

Generally, grounding system are really important to protect people since majority of faults are caused by poor grounding system. Poor grounding not only contributes to unnecessary incident, but also dangerous which can increase the risk of equipment failure [2]. The grounding resistance is affected by the material used in grounding, soil resistivity, depth of ground rod, type of soil and also the grounding system design [3-6]. Therefore, a good grounding system must consider the aforementioned aspects to produce a good grounding system.

*Corresponding author: ndiana@uthm.edu.my
2020 UTHM Publisher. All rights reserved.
publisher.uthm.edu.my/proceeding/index.php/eeee

The standard driven rod is used as grounding in several places in Earth to discharge the overvoltage especially from lightning strikes. It is believed that the grounding system can be improved by modifying the grounding rod of existing system. A number of possible future method and design can be proposed to improve the grounding system by investigating and modifying several specific areas such as the type of rod used, suitable place for grounding and the soil resistance itself. The shape of standard rod is similar to the shape of a nail that easily penetrates through the soil. The only disadvantage of using this type of rod is the step voltage on earth surface can be higher under a large fault current or during a direct lightning strike. Therefore, a new design of grounding rod shape is proposed in this paper to investigate the grounding resistance.

2. Materials and Methods

2.1 Grounding rod material selection

Copper and iron materials was used in this work for the grounding rod construction as both materials are excellent conductor and low cost. According to research conducted by [7], copper is corrosion-resistant underground; thus, copper will allow the flow of fault current smoothly to the earth when copper is buried underground. Moreover, it is found that copper conductors have a better performance with low ground resistance than steel conductors [8]. Apart from that, copper and galvanized iron material was utilized in the Telekom Malaysia research for good grounding system yet to be economical [9]. It was found that the utilization of copper and iron material as grounding rod for soil resistivity experiment are reasonable and affordable. The resistivity of copper and iron are tabulated in Table 1.

Table 1: Resistivity of the materials

No	Material	Resistivity	Coefficient
1	Copper	1.72×10^{-8}	0.0039
2	Iron	1.0×10^{-7}	0.005

2.2 Design of rods

The prototypes of standard, three branches and five branches grounding rod for copper and iron materials was developed by cutting and welding the combination of branches based on the size as shown in Table 2.

Table 2: Rods specifications

No	Type of rod	Prototype	Parameters
1	Standard copper		Length: 700mm Diameter: 12mm

2

Standard iron



Length:700mm
Diameter:9.525mm

3

Three branches copper



Length:700mm
Branch length:200mm
Diameter:12mm

4

Three branches iron



Length:700mm
Branch length:200mm
Diameter:9.525mm

5

Standard copper



Length:700mm
Diameter:12mm

6

Five branches iron

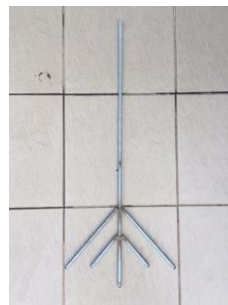

Length:700mm
Branch length:300mm
Diameter:9.525mm

2.3 Wenner four point method

Figure 1 shows the configuration of Wenner Four Point method used to measure the soil resistivity in grounding system. Four electrodes were used in this method where two electrodes are used for current injection (C1 and C2) while the other two electrodes is used for voltage measurement (P1 and P2). The depth of the rod shall not exceed the value $a/20$. The resistance can be measured and calculated according to the Eq. 1.

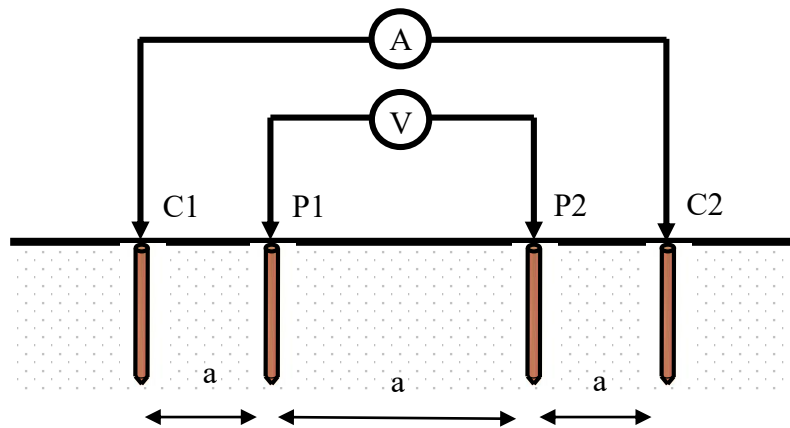

Figure 1: Wenner four point method configuration

$$\rho = 2\pi aR \quad \text{Eq. 1}$$

Where: ρ = Resistivity in Ohm-cm

a = spacing between pin in cm

R = Resistance measurement in Ohm

It is important note that the first experiment was conducted using the standard rods to obtain the result of the soil resistivity as well as for reference purposes. Next the standard rods was replaced by the spike rods and the data of soil resistivity was collected and compared for both types of rods. The actual measurement setup for Wenner Four Point method is depicted in Figure 2.

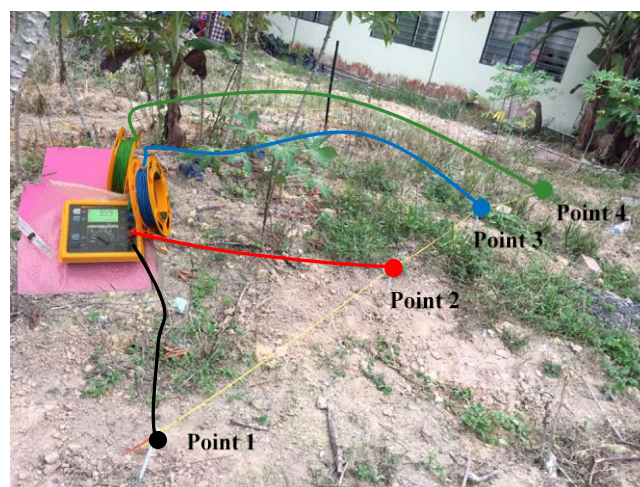

Figure 2: Connection earth ground tester to rods

3. Results and Discussion

3.1 Comparison soil resistivity between standard copper and standard iron rod

Figure 3 illustrates the comparison graph of soil resistivity between standard copper and standard iron rod. It is observed from the graph that the standard rod with copper material has lower soil resistivity value compared to the standard iron rod. However, iron rod experienced a slight increase in soil resistivity which may lead to a poor grounding system.

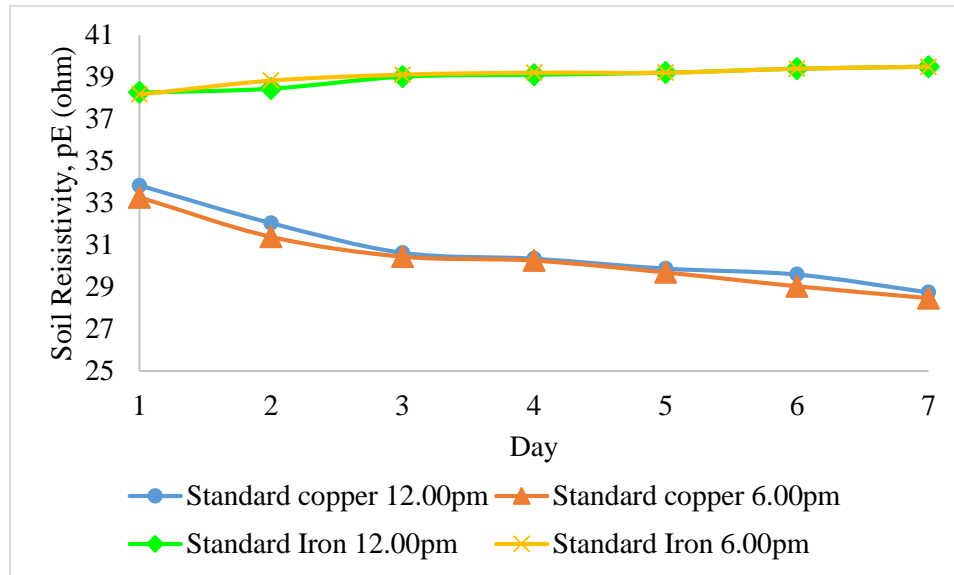

Figure 3: Comparison of soil resistivity between standard copper and standard iron rod

3.2 Comparison soil resistivity between three branches copper and three branches iron rod

Figure 4 shows the comparison graph of soil resistivity between three branches copper and iron rod. It is noticed that the soil resistivity reading for three branches of copper rod seems more stable compared to the iron rod. However, the soil resistivity reading for three branches iron rod keeps increasing day by day.

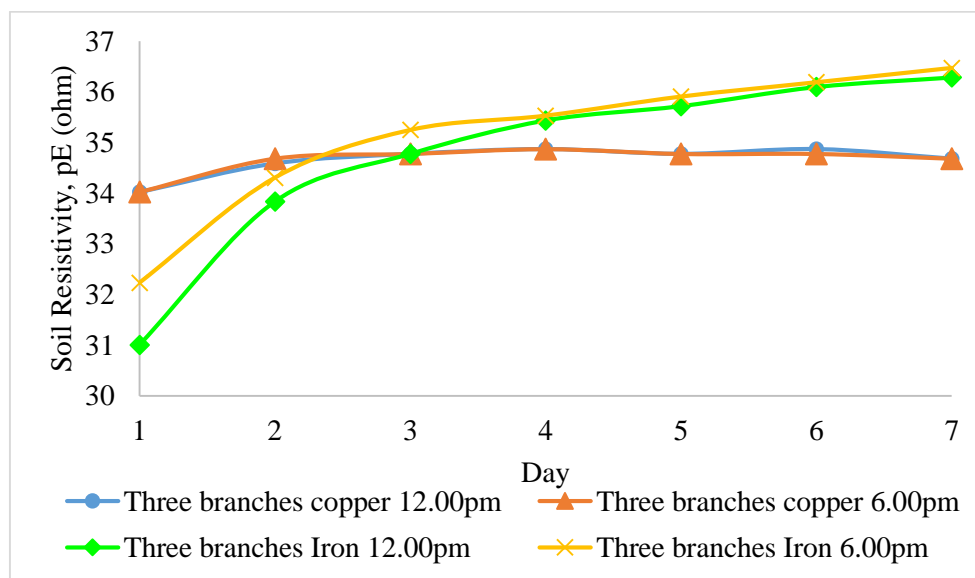

Figure 4: Comparison of soil resistivity between three branches copper and iron rod

3.3 Comparison soil resistivity between five branches copper and five branches iron rod

The comparison graph of soil resistivity between five branches copper and iron rod is depicted in Figure 5. It is apparent from the presented result that the soil resistivity for five branches copper rod is lower compared to the five branches iron rod. It is interesting to note that the soil resistivity trend for copper rod seems to be more stable while the trend of soil resistivity for iron rod increase slightly.

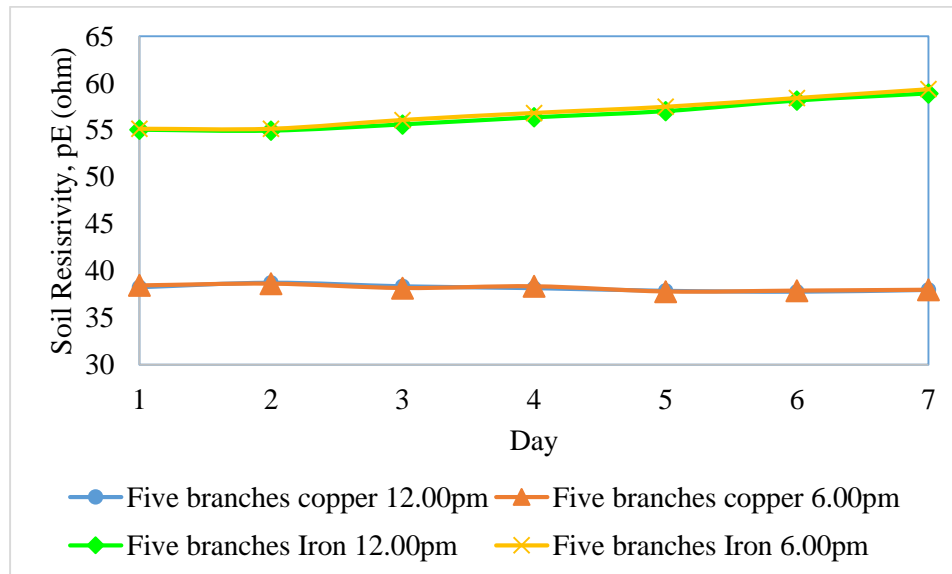
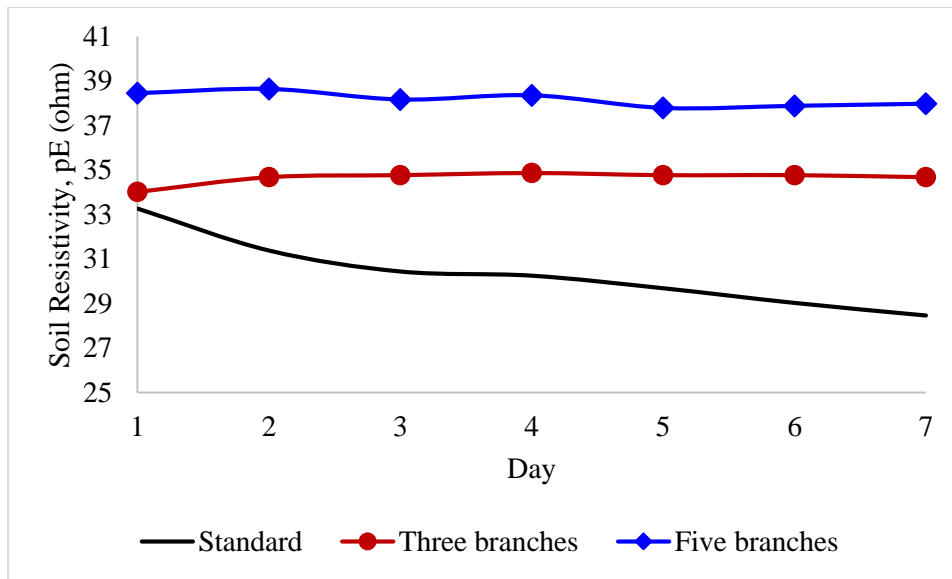

Figure 5: Comparison of soil resistivity of five branches copper and iron rod

It can be concluded from the presented results in Figure 3 to 5 that the value of soil resistivity for copper rod is smaller than iron rod for all rod designs. This is because copper material has higher conductivity compared to iron and work efficiency as a good conductor to conduct the fault current or voltage to the ground. As known, the soil resistivity needs to be low for a good grounding system and for this case the copper rod is believed to improve the grounding.

3.4 Comparison between copper and iron material

The comparison graph of soil resistivity between standard, three and five branches for copper and iron rod is illustrated in Figure 6. The lower soil resistivity value is found in the standard rod as shown in Figure 6 for both materials. Meanwhile, the five branches of copper and iron rod contributes to a higher soil resistivity compared to the other type of rods.



(a)

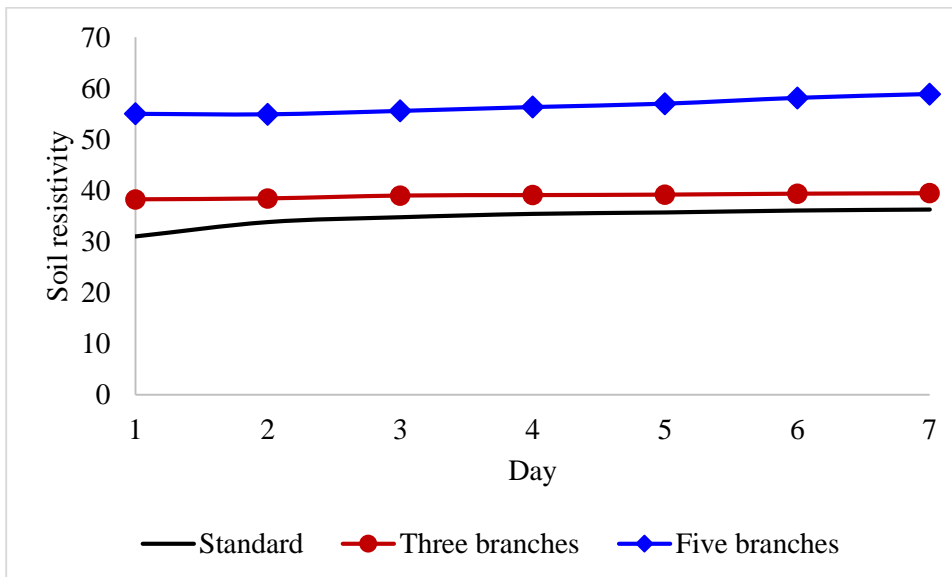

(b)

Figure 6: Comparison of soil resistivity between standard, three and five branches for (a) copper rod and (b) iron rod

3.5 Comparison soil resistivity between smooth surface of rod and groove surface of rod.

Figure 7 shows the pictorial view of smooth and groove surface rods used in this work. The comparison graph between smooth and groove surface rod is depicted in Figure 8. It is observed that the smooth surface rod produces low soil resistivity compared to the groove surface rod. From this result, a smooth surface is more preferred than groove surface rod for the grounding system. This result cannot be verified 100 percent because of several factor such as the moisture of soil, depth of the rod, and also humidity of soil that affect the soil resistivity value.

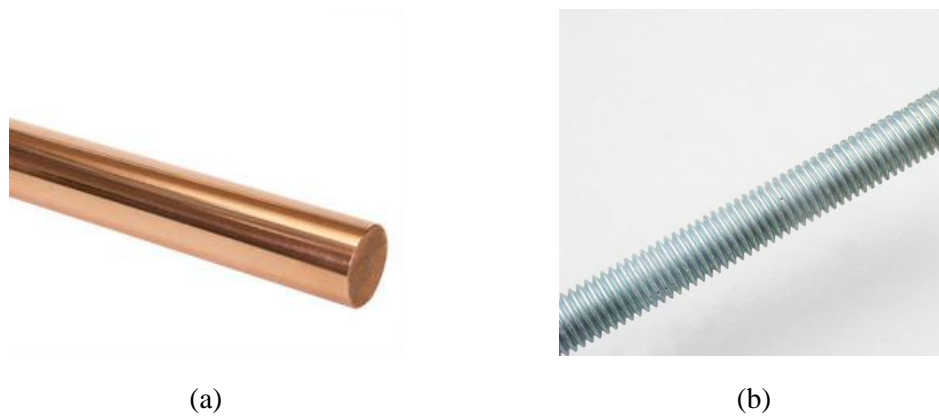

Figure 7: (a) smooth surface rod, and (b) groove surface rod

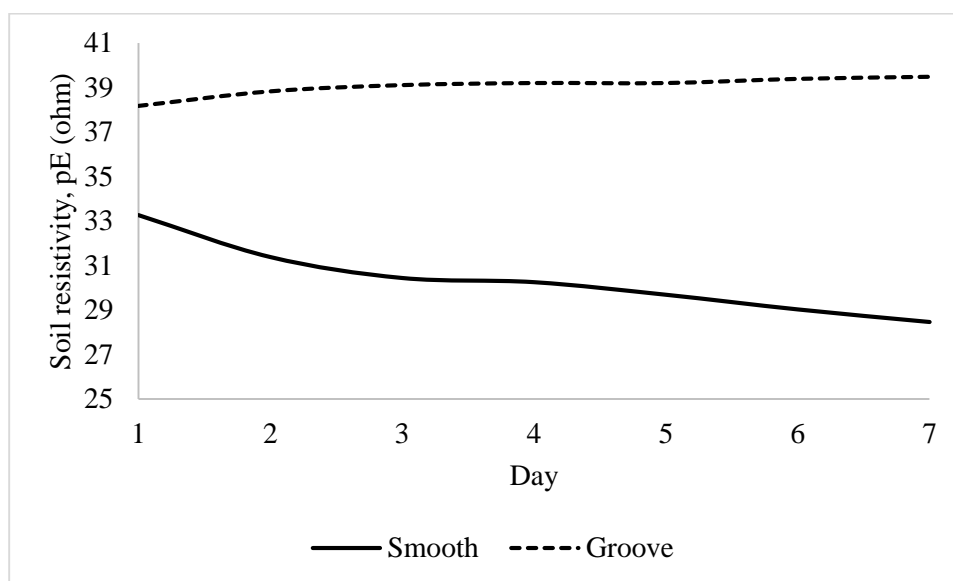

Figure 8: Comparison graph between smooth and groove surface rod

3.7 Overall

Based on the presented results, the standard rod can be considered as the best design for a good grounding system since it has the lowest resistance value followed by the three branches rod and five branches rod. This is because the size of three branches rod and five branches rod are different due to additional branches that increase the parameter of the rods. If the parameter of the rod designs increases, the resistance of the rod will also increase and produce high soil resistivity soil. The calculation of resistance of the rod is tabulated in Table 4 using the Eq. 2.

$$Resistance, R = \rho \left(\frac{L}{A} \right) \quad \text{Eq. 2}$$

where,

ρ = Material resistivity

L = Length of rod in meter (m)

A = Cross sectional area in meter (m)

Table Error! No text of specified style in document.: Resistance of rods design

No	Type of rod	Total Length, L (m)	Total Length, L (m)	Cross sectional area, A (m ²)
1	Standard copper	0.7	1.131×10^{-4}	1.06×10^{-4}
2	Standard iron	0.7	7.126×10^{-5}	0.98×10^{-3}
3	Three branches copper	0.9	1.131×10^{-4}	1.37×10^{-4}
4	Three branches iron	0.9	7.126×10^{-5}	1.26×10^{-3}
5	Five branches copper	1.0	1.131×10^{-4}	1.52×10^{-4}
6	Five branches iron	1.0	7.126×10^{-5}	1.40×10^{-3}

4. Conclusion

Based on the present work, an experimental study on soil resistivity using different rod design and material for grounding system is presented. It is shown from the presented results that standard copper rod have lower soil resistivity compared to iron rod. It can be concluded that more branches of the rod can increase the soil resistivity value. The result also proves that copper rod material exhibits better soil resistivity reading compared to the iron rod material.

Acknowledgement

The authors express their sincere gratitude to the Faculty of Electrical and Electronic Engineering, Universiti Tun Hussein Onn Malaysia (UTHM) for the use of facilities and equipment supports.

References

- [1] Yu, Luke, and Roy T. Beck. "Safe grounding practices and recommendations for industrial facilities," in Record of Conference Papers Industry Applications Society 39th Annual Petroleum and Chemical Industry Conference. 1992. pp. 165-170
- [2] Babrauskas, Vytenis. Electrical fires. Springer, New York, 2016
- [3] S. C. Malanda, I. E. Davidson, E. Singh, and E. Buraimoh, "Analysis of Soil Resistivity and its Impact on Grounding Systems Design," 2018 IEEE PES/IAS PowerAfrica, PowerAfrica 2018, no. August, pp. 324–329, 2018
- [4] M. A. Salam, Q. M. Rahman, S. P. Ang, and F. Wen, "Soil resistivity and ground resistance for dry and wet soil," J. Mod. Power Syst. Clean Energy, vol. 5, no. 2, pp. 290–297, 2017
- [5] G. N. M. Nassereddine, and J. Rizk, "Soil Resistivity Data Computations; Single and Two - Layer Soil Resistivity Structure and Its Implication on Earthing Design," Int. J. Electr. Comput. Eng., vol. 7, no. 1, pp. 35–40, 2013
- [6] J. Liu, "Analysis of Current Density in Soil for Resistivity Measurements and Electrical Grounding Designs," J. Electr. Electron. Eng., vol. 5, no. 5, p. 198, 2017
- [7] J. He, R. Zeng, and B. Zhang, "Methodology and Technology for Power System Grounding," Methodol. Technol. Power Syst. Grounding, 2012
- [8] S. Steel, Y. Li, J. Ma, and F. P. Dawalibi, "Power Grounding Safety," Power Syst. Technol., 2006
- [9] A. Ahmad, M. R. A. Saroni, I. A. W. A. Razak and S. Ahmad, "A case study on ground resistance based on copper electrode vs. galvanized iron electrode," 2014 IEEE International Conference on Power and Energy (PECon), Kuching, 2014, pp. 406-410