

Solar-Powered Flood Monitoring System with IoT

**Nur Adli Nasir¹, Munirah Ab. Rahman^{1*}, Zarina Tukiran¹,
Nurulhuda Ismail¹**

¹Faculty of Electrical and Electronic Engineering,
University Tun Hussein Onn Malaysia, Batu Pahat, 86400, MALAYSIA

*Corresponding Author Designation

DOI: <https://doi.org/10.30880/eeee.2023.04.01.075>

Received 03 February 2023; Accepted 09 April 2023; Available online 30 April 2023

Abstract: Flood is one of the most common environmental disasters in east coast of Malaysia. Flood can be affected to the local, or very large neighborhood or community at the entire river basins. Flood can happen slowly, but sometimes flash flood can occur very fast. In some flood areas especially in the rural places, there are still no establishment of flood warning system to give a warn to the local villages about the upcoming flood. For other places with onsite measurement river water level, the system is lacking the ability to log, send and monitor the data in real time. In addition, the system with battery power supply may face battery drainage issue in which will affect the process of water level measurement. Therefore, a flood detection system has been developed in which capable of measuring the river level automatically. The system can log, send, and monitor data in real time using IoT technology. The system circuit is equipped with solar panel as the power supply and can give warning to local people about upcoming flood by using buzzer and Android application. With real time flood information and warnings, this will allow local people to have effective preparation in facing the flood, hence minimize the losses during flood event.

Keywords: Flood Monitoring, Solar Panel, Internet of Things (IoT)

1. Introduction

Flood is one of major disaster, affect the lives of million people and animal also cause a lot of damage throughout the world. People losing their houses, cars, and properties also livestock during flood. Flooding caused by combination of human and natural factors such as heavy monsoon rainfall, poor drainage, illegal logging, and other local factors[1] [2]. In addition, the unpredictable weather with occasional rains also be the reason for flood in certain places.

Flood in Malaysia occur at least twice a year, Citizen of Malaysia consider that flooding is an annual event every year. Malaysia is one of country that has high temperatures and humidity, heavy rainfall, and a climatic year patterned around the northeast and southwest monsoons [3]. In Malaysia, flood frequently happen in east coast peninsular of Malaysia especially in Kelantan, Terengganu, and Pahang. East coast peninsular Malaysia experiences heavy rainfall from November to January. Based on Malaysian Meteorological Department (MET) data shows that the mean monthly rainfall in East coast Malaysia receive 3000mm to 3500mm precipitation which is the highest state receive rainfall in peninsular Malaysia [3].

Flooding in Malaysia not only affect the people, life and properties loss but also annihilate plant and farm animals which is the number one food sources in Malaysia. As reported in [4] the flooding that affected several states in the late of 2021 and early 2022 resulted Malaysia government overall losses of RM6.1 billion. Flood can happen very fast and unpredictable in some places [2]. It is very necessary to have early detection to warn local people about the risk and threat when there is upcoming flood. Having monitoring and alert system become important requirement to help people preparation in facing the upcoming floods by monitoring the level of river water in their place. This proposes project focuses on rural area especially in Kg Wakaf Stan, Kelantan, due to lack of information among villager about flood prediction. Therefore, the flood monitoring with Internet of Things (IoT) has been developed. The system will be using an IoT platform with some sensors which will enable user to remotely check the current condition of river water level by using their smart device such as smartphone and computer. Alarm notification is triggered when the river water level reaches the danger level.

2. Materials and Methods

The systematic, theoretical analysis of the procedures used in a field of research is known as methodology. It includes the concepts, theoretical model, and stages that linked to the project. This section provides a detailed overview of the technique that is applied to finish and test this project. The approach is being used to fulfil the project’s goal of achieving a good result. The method used to analyse this project is based on the flood detection and warning system using IoT, which consists of three key steps which are planning, implementation and analysis.

2.1 Design Concept

The solar-powered flood monitoring system with IoT is designed to sense the water level and to measure whether it is in normal condition or reach the water limit level. The system also collects data from sensor, stores it into ThingSpeak platform web server and monitors data from the platform. The proposed system provides simple and basic Android application monitoring interface and cost-effective system. The block diagram in Figure 1 consists of ESP 8266 as a single microcontroller that receives the input signal from ultrasonic sensor and providing output by sending data to ThingSpeak web server and triggered the buzzer and LED. The system flowchart shows as in Figure 2.

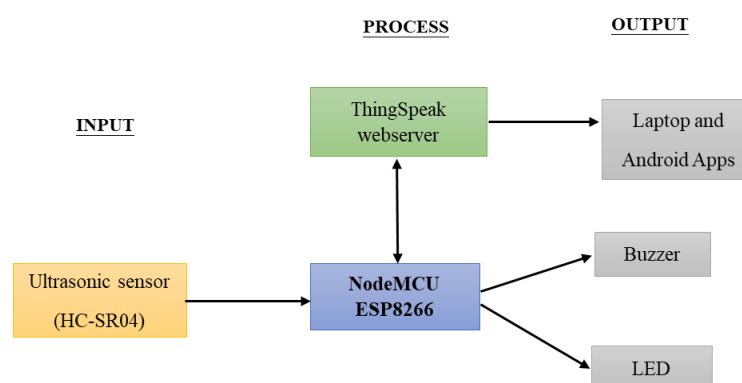

Figure 1: System Block Diagram

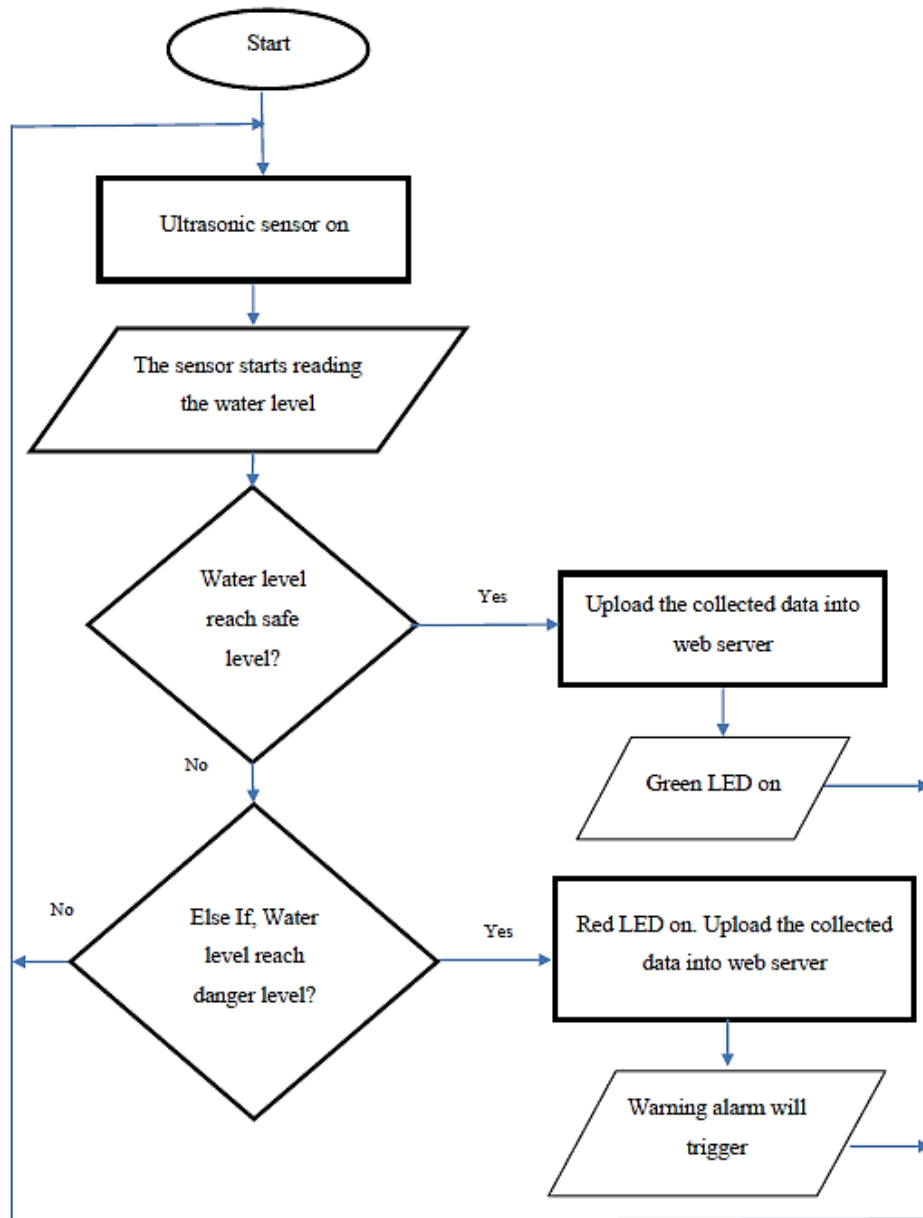

Figure 2: System flowchart

2.2 Solar-powered flood detection circuit

The main goal of this project is to develop the device that can measure the water level. The circuit of the device contains a Node MCU ESP8266 as microcontroller, Ultrasonic Sensor, a buzzer, 2 LED for light indicator and a 3.7V rechargeable lithium battery. Figure 3 shows the schematic circuit for the solar-powered flood monitoring device.

2.2.1 Ultrasonic sensor HC-SR04

The HC-SR04 Ultrasonic Distance Sensor is a sensor used for detecting the distance to an object using sonar. This sensor provides excellent non-contact range detection between 2 cm to 400 cm (13 feet) with an accuracy of 3 mm. Since it operates on 3.3 and 5 volts, it can be connected directly to an Arduino or any other supported logic microcontroller.

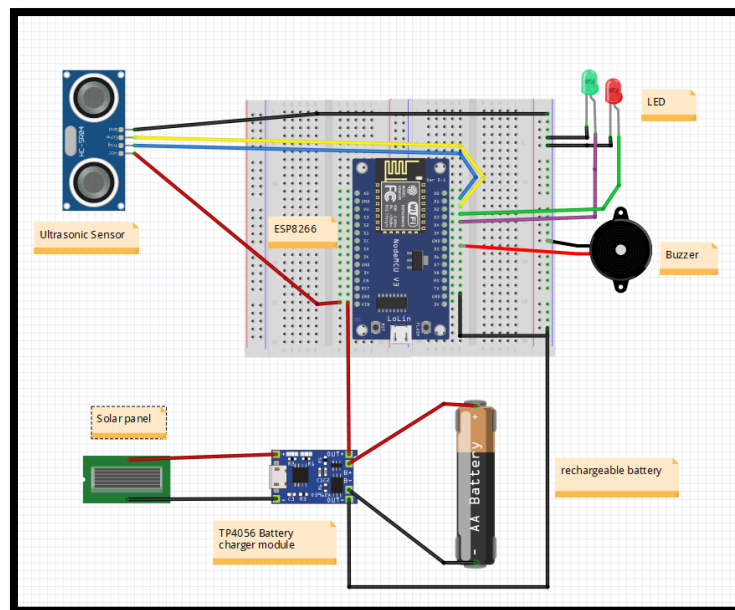

Figure 3: Solar-powered flood monitoring device circuit on fritzing software

2.2.2 Solar Panel with TD4056 Battery Charger Module

The solar panel and TD4056 are components used for charging the rechargeable battery. This method will save time and can work simultaneously with the system. The system can operate 24 hours without shutting down the system to charge the battery.

This IoT system uses low power consumption with 3.3V, so the rechargeable battery was used to power up the device. The rechargeable lithium battery 3.7V has been used for this project. Since it is rechargeable, the battery needs to charge every couple of hours. To charge the battery need to use the wall charger and can disrupt the collecting data process because the charging process cannot be done in experimental site. After realizing the problem, this project used the solar panel charger. By using the solar panel charger, the battery can be charged simultaneously with collecting data. The main component for panel solar charger is 1W, 6V Solar panel and TP4056 lithium battery charger module.

2.3 Monitoring system development

The flood monitoring system uses the IoT technology and android application in its implementation. Figure 4 shows the flowchart for IoT monitoring system development process. The monitoring system development consists of the process of designing the programming code and setup the IoT platform. The process starts with choosing a suitable compiler. This project use Arduino IDE as a compiler. The Arduino IDE is a simple and friendly user software to design the code and easily can upload to the device. This project use C++ programming language because it is easy to understand and compatible with the NodeMCU ESP-8266 microcontroller.

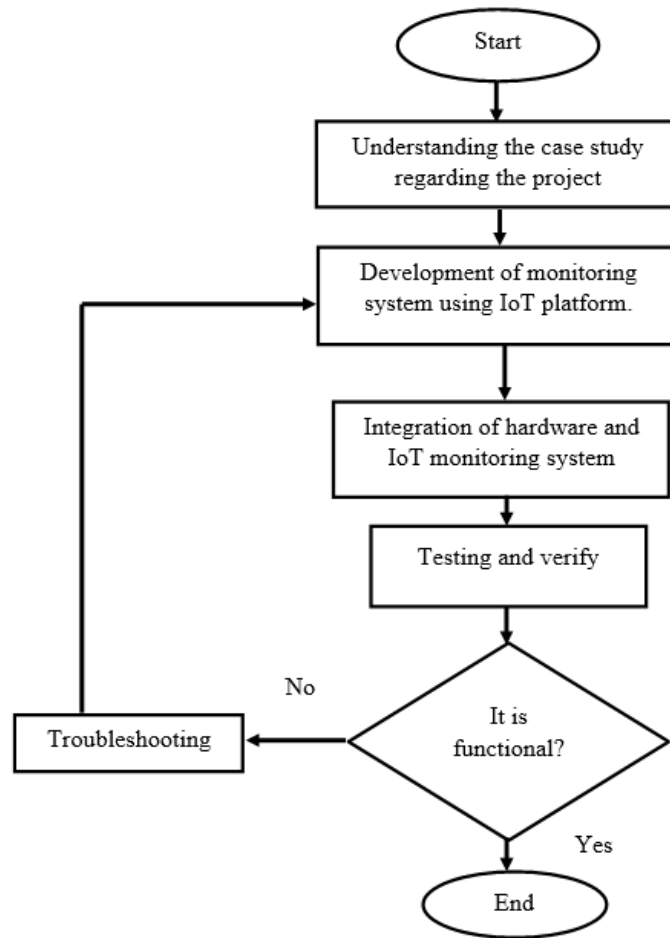

Figure 4: The flowchart for IoT monitoring system development process

2.3.1 IoT platform

IoT platform setup process starts with browsing to the IoT web-based website thingspeak.com to create the account and start with new project by adding the monitor feature into it.

2.3.2 Android Application

The Android Application setup in this project use the Android Studio IDE. The Android Studio IDE is the official SDK software from Android. This Android apps design use the Java programming language. In Android Studio IDE can design the interface and functionality of the application.

2.4 Evaluation Method of Project Functionality

This system is applied in real implementation. The selected place is in Pura Kencana at Sri Gading, Batu Pahat Johore. The main reason why choosing this place because it is near with house and there are not so crowded with other peoples. Next, the lake has a path to water flowing in and out to other nearby lakes. From the water pathway can easily to detect the increasing and decreasing water level. The experiment is set up at top of water pathway because it has flat concrete so the device can easily place as in Figure 5.



Figure 5: The water pathway to other nearby lakes and flat concrete surface

Figure 6 shows the position of the flood detection circuit being set up onsite in which the ultrasonic sensor is at the same level as the land surface, facing down to the river. With this position, the circuit can measure the river water level accordingly. The onsite set up is to evaluate the system functionality. Furthermore, it also tests the circuit reliability to run in different types of weather by collecting the river water level (cm) data in 6 days.



Figure 6: Water level height and land surface

3. Results and Discussion

This section provides the result of the solar-powered flood monitoring system with IoT. The result is discussed based on project's objectives and collected data in real implementation.

3.1 Solar-Powered Flood Detection Circuit

The device consists of ESP8266, ultrasonic sensor, battery charger module, rechargeable battery, solar panel, LED and alarm. The panel solar is placed on top of device case. The solar panel position is important to ensure the panel receive enough sunlight for the charging process. All arrangement and connection of the component show in Figure 7.

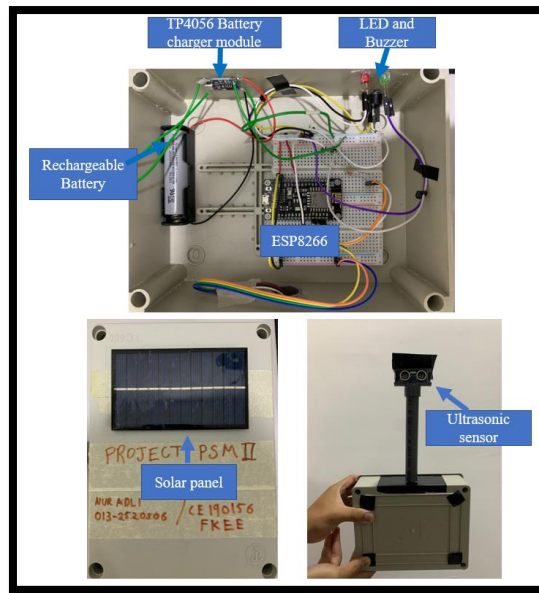

Figure 7: Solar-Powered flood monitoring device

3.2 Water Level Measurement

This project is to build a circuit that can measure the river water automatically. The measurement data include the water level (cm), the time and date. For the analysis, the circuit measure the water level for 6 days, from 28 December 2022 until 2 January 2023. The measurement data was collected 11228 times in every 15-23 seconds, collecting the distance of water level toward to the sensor. A long-distance value means the river water is low and a short distance value means the river water is high from the sensor or land surface. Meanwhile lowest value is near to land surface. Figure 8 to Figure 13 are the graphs of average data from 28 December 2022 until 2 January 2023 hourly.

3.2.1 Data Analysis in Days

From Figure 8, the graph shows the average data on every hour. The highest value is the highest distance of water level toward to the sensor. From the graph, it can be seen the highest water measurement is at 1900 hours with average 109.7 cm from the sensor. Meanwhile the lowest distance toward the sensor recorded at 0000 hours with 109.2 cm.

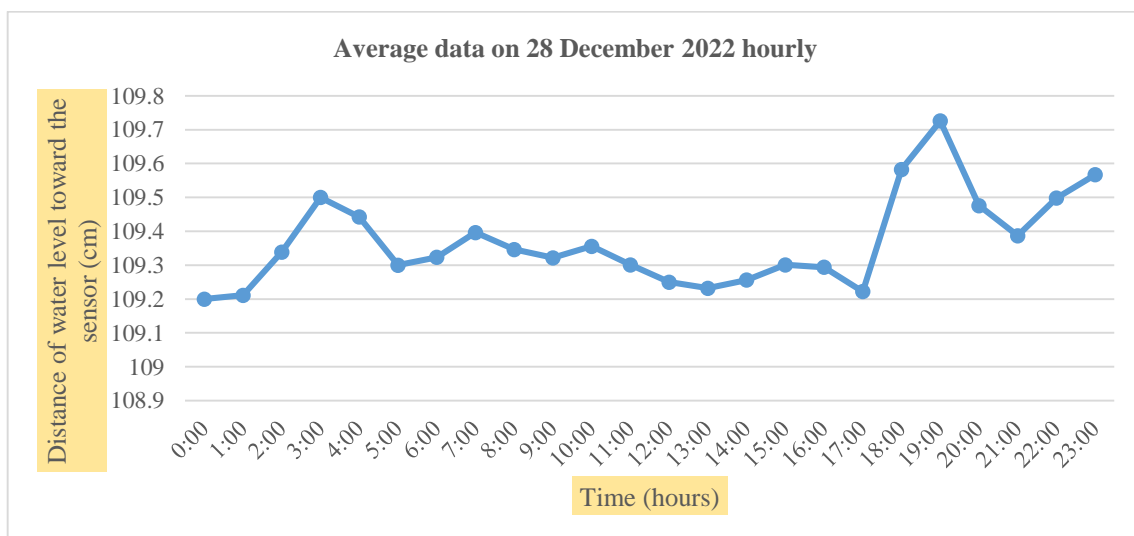

Figure 8: Graph for 28 December 2022 hourly

Figure 9 shows the graph for average data on 29 December 2022 hourly. From the graph, the highest peak value is at 1100 hours and 2000 hours with 110.278 cm. The lowest is on 1500 hours with 109.89 cm. From Figure 9, the graph trend is increasing compared to Figure 8.

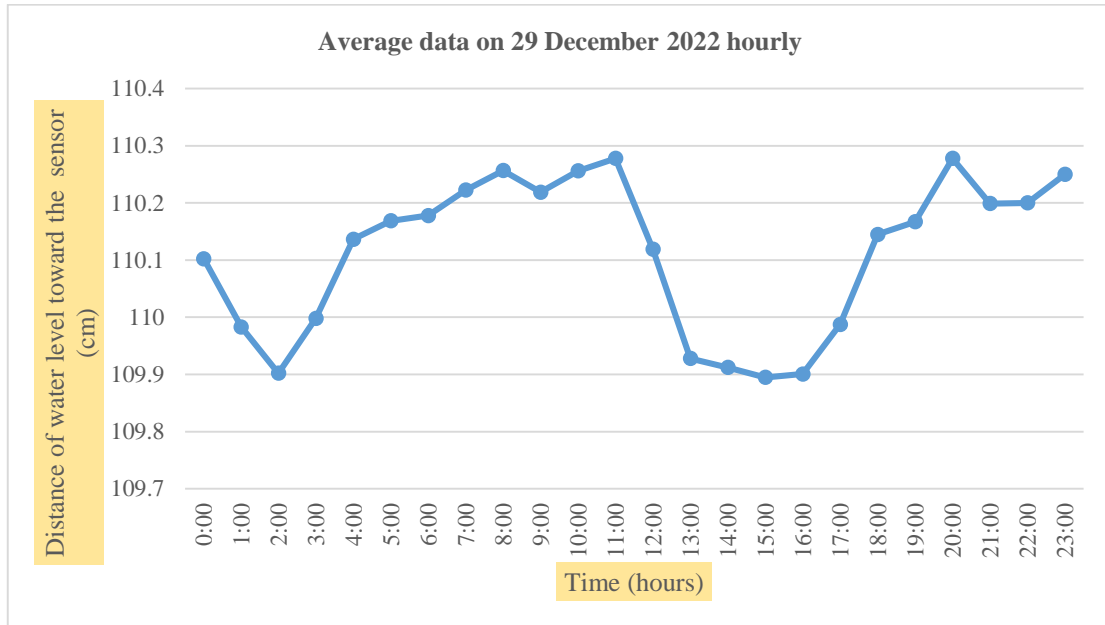

Figure 9: Water level graph for 29 December 2022 hourly

Figure 10 shows the graph on 30 December 2022. The highest distance value for 30 December is 111.2 cm at 1800 hours and the lowest value is 101.47 cm at 2000 hours. The graph shows the constant line from 0000 hours until 1200 hours but showing the decreasing trend start from 1900 hours because of raining weather. Due to the raining weather, the distance value starts to decreasing from 111.2 cm to 101.47 cm. The rain starts at 1800 hours and continue to the next day which is 31 December 2022.

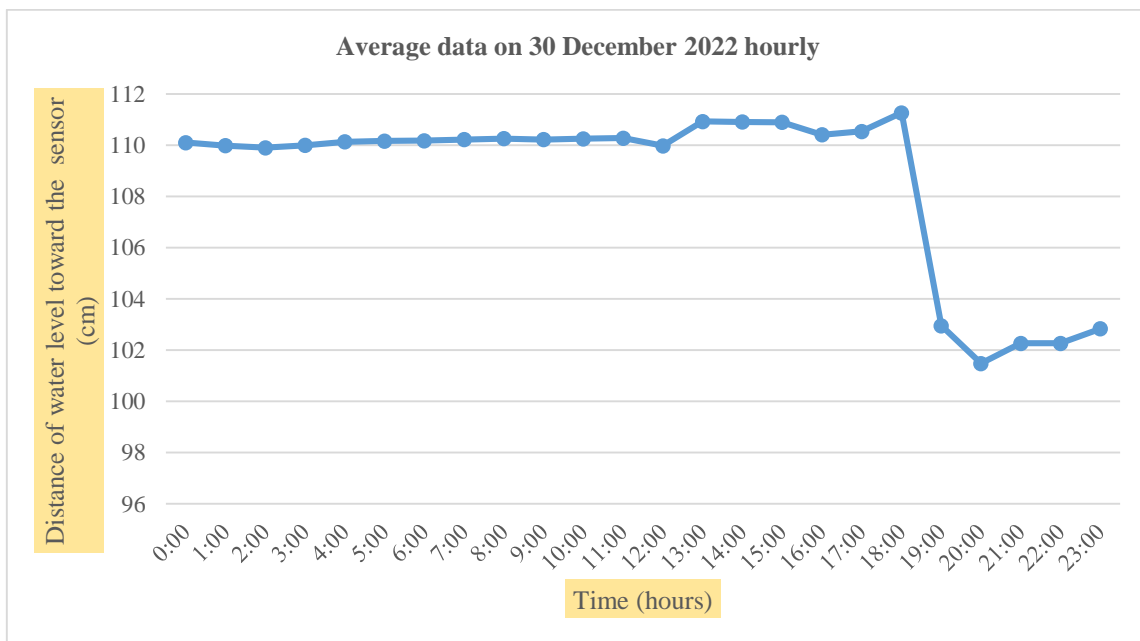

Figure 10: Water level graph for 30 December 2022 hourly

The raining is continued from the 30 December and stop in the morning on 31 December 2022. Figure 11 shows the graph is increasing at every hour starting in the morning. The lowest value is at 0000 hours with 104.02 cm and the highest is 107.57 cm at 2100 hours.

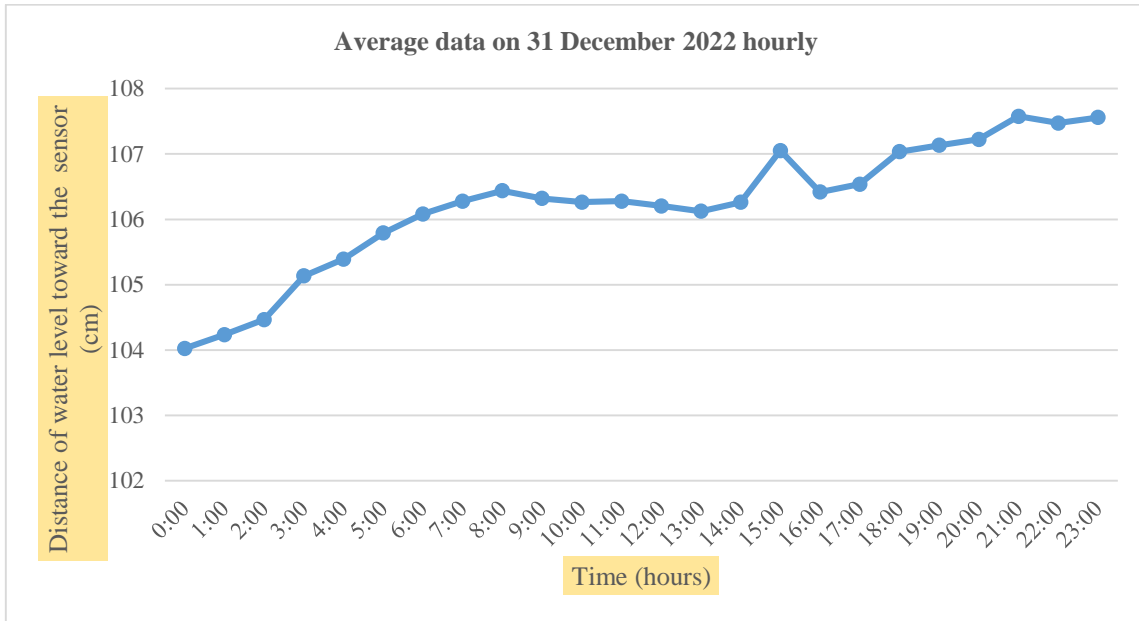

Figure 11: Water level graph for 31 December 2022 hourly

Figure 12 shows the graph for 1 January 2023. The overall graph shows the increasing trend with the highest value is 109.8654 cm at 2300 hours and the lowest 107.2 at 1300 hours. While in Figure 13, the graph shows average data on 2 January 2023. The highest value is 111.1042 at 2300 hours and the lowest 109.0175 at 1500 hours.

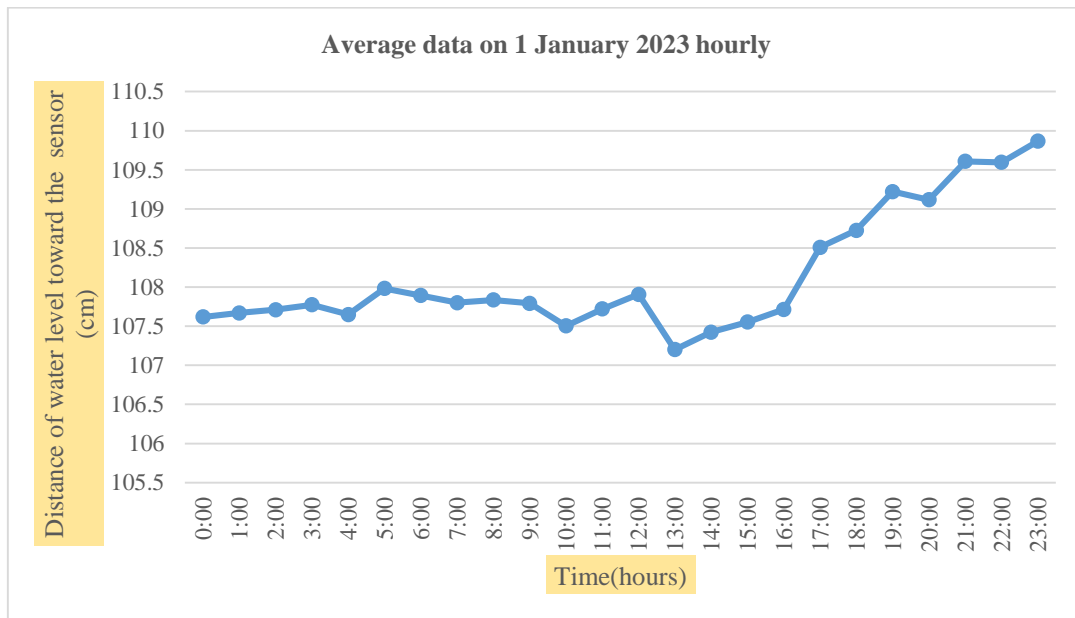

Figure 12: Water level graph for 1 January 2023 hourly

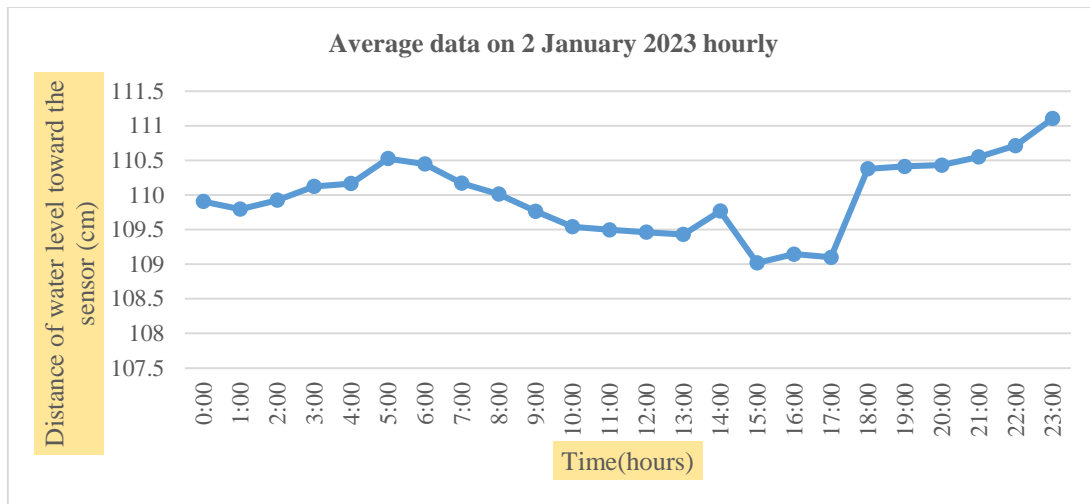

Figure 13: Water level graph for 2 January 2023 hourly

3.2.2 Average Water Level Measurement Data Analysis

Table 1 shows the average water level measurement from 28 December 2022 until 2 January 2023. From the table, the normal day is on 28, 29 December 2022 and 1 and 2 January 2023. Meanwhile rainy days are on 30 and 31 December 2022. To sum up the analysis, the comparison between total average for normal day is 109.3984 cm and total average for raining day is 107.4525 cm from land surface. Figure 14 shows the distance starts decreasing on 29 December 2022 and starts increasing on 31 December 2022. From the comparison, it can be concluded that during a rainy day the distance decreases 3.89 cm.

Table 1: Average distance of water level per day

Date	Distance of water level toward the sensor
28/12/2022	109.367
29/12/2022	110.111
30/12/2022	108.684
31/12/2022	106.221
1/1/2023	108.1415
2/1/2023	109.9739

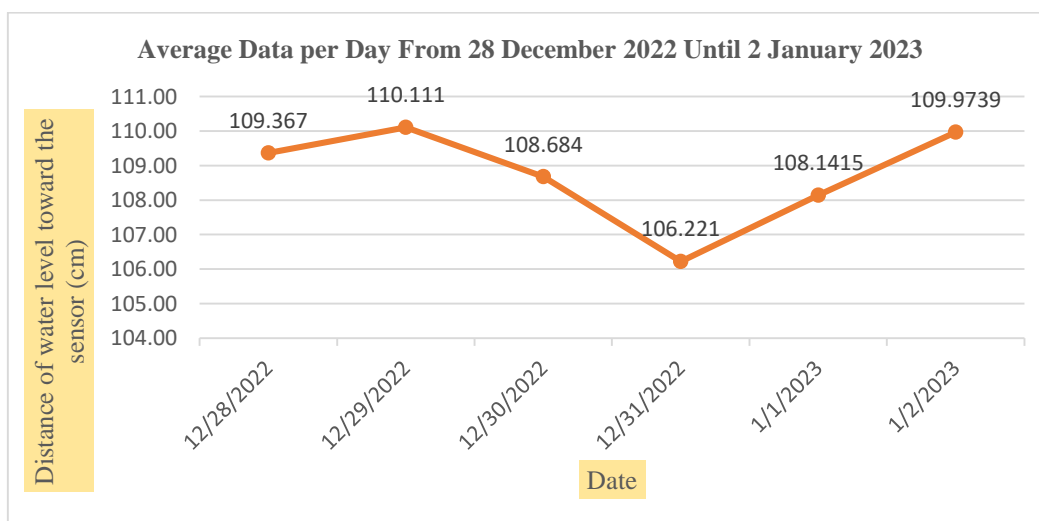

Figure 14: Graph for average data by day

3.3 Flood Monitoring System

The flood monitoring system is using the IoT platform which is ThingSpeak webserver. The webserver is used to store and show the collected data in a simple and attractive interface.

3.3.1 ThinkSpeak Platform

The setup of the ThingSpeak webserver is from creating specific channel and channel configuration. For this project, the data show in graphical graph, light indicator, and gauge meter. All this data is from the ultrasonic sensor, the data is measurement of the water level (cm) and time. There are two statuses that has been configured in ThingSpeak which is Safe status and Warning status.

3.3.2 Android Application

Since nowadays all people have smartphone, the system includes the Android application for monitoring purpose. Android apps is smartphone application so the user can easily monitor the water level in their location easily from the smartphone. The design of the apps is simple and minimalist style. The target of the design is to be user friendly to use the apps and can understand how the apps works. The overall design of Android apps is in Figure 15.

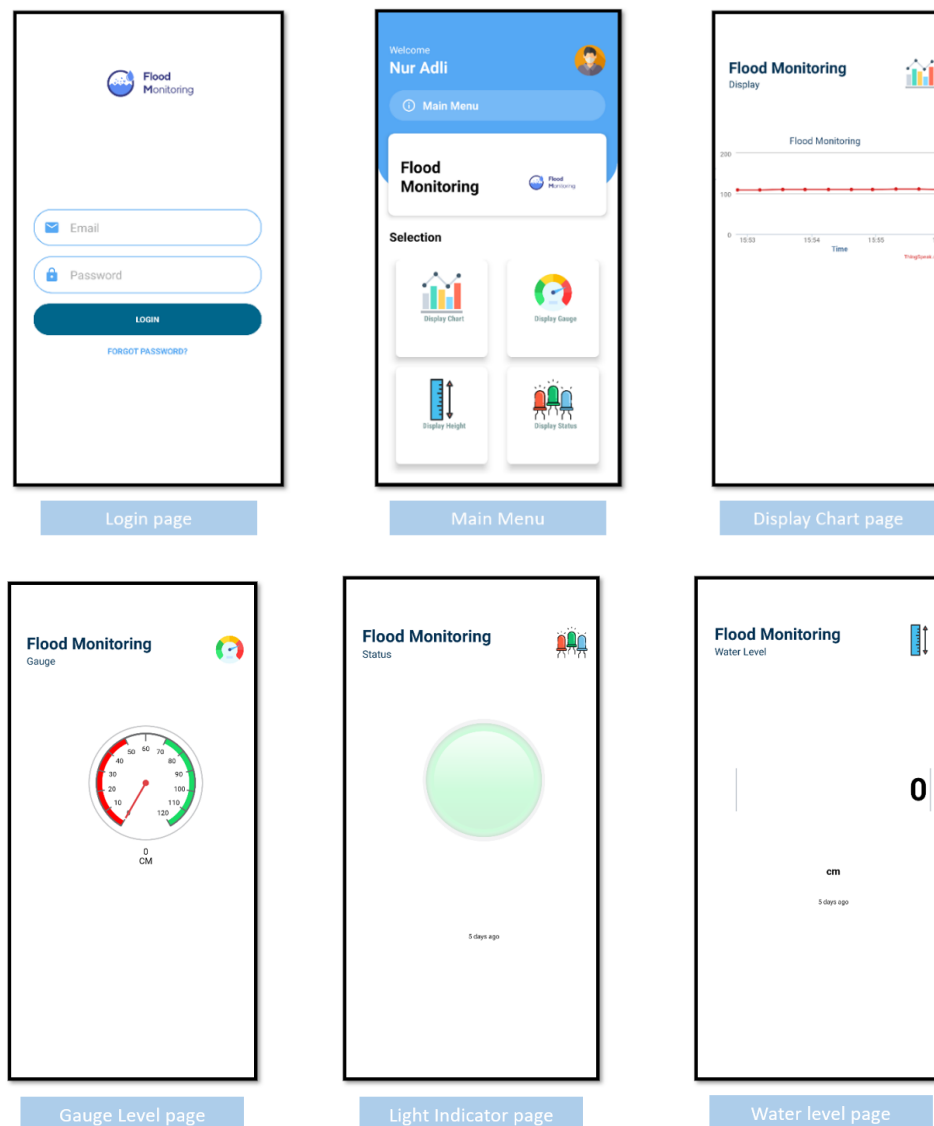

Figure 15: The Android application interface

From Figure 15, the application is designed specific for the system. The application interface consists of 6 pages. First page is login page, the user needs to login their account or username and password. After the login page, user will enter the main menu of the application. In the main menu page, the user can select the multiple features to show the output result of monitoring system. The selection that this application has is display chart, display gauge, display water level height, and display light indicator. All the output display is linked with the ThingSpeak webserver data simultaneously.

4. Conclusion

This project has successfully developed a device that can measure the water level and storing data on the webserver. The data from the sensor can be monitored from the specific Android application and ThingSpeak webserver. The device is fully powered using sustainable energy from solar panel, rechargeable battery and can automatically charge the battery when solar panel detected sunlight. The collection data proves the functionality of the device in real implementation. Further research with the latest microcontroller board and sensors can improve the level of accuracy of data taken and improve the networking connection.

Acknowledgement

The authors like to thank the Faculty of Electrical and Electronic Engineering, Universiti Tun Hussein Onn Malaysia for its support.

References

- [1] M. S. Mohd Sabre, S. S. Abdullah, and A. Faruq, 'Flood Warning and Monitoring System Utilizing Internet of Things Technology', *Kinetik: Game Technology, Information System, Computer Network, Computing, Electronics, and Control*, pp. 287–296, Oct. 2019, doi: 10.22219/kinetik.v4i4.898.
- [2] S. Binti Zahir et al., 'Smart IoT Flood Monitoring System', in *Journal of Physics: Conference Series*, Dec. 2019, vol. 1339, no. 1. doi: 10.1088/1742-6596/1339/1/012043.
- [3] Malaysian Meteorological Department (MET), 'Perubahan Hujan Bermusim di Semenanjung Malaysia', 2022.
- [4] Bernama, 'Floods erode property value by 30 pct, says experts', *New Straits Times*, Malaysia, Nov. 24, 2022.