

Implementation of Solar Charge Controller for Uninterruptible Power Supply

Ahmad Mustaqim Rosli¹, Nor Akmal Mohd Jamail^{1*},
Qamarul Ezani Kamarudin²

¹Faculty of Electrical and Electronic Engineering,
Universiti Tun Hussein Onn Malaysia, Batu Pahat, 86400, MALAYSIA

²Faculty of Mechanical and Manufacturing Engineering,
Universiti Tun Hussein Onn Malaysia, Batu Pahat, 86400, MALAYSIA

*Corresponding Author Designation

DOI: <https://doi.org/10.30880/eeee.2023.04.02.072>

Received 30 January 2023; Accepted 04 July 2023; Available online 30 October 2023

Abstract: Solar charge controller (SCC) and uninterruptible power supply (UPS) are different types of devices. SCC is an important element in the solar electric panel system while UPS is a device that allows any load to keep functioning for at least a short time when there is a power failure. The solar charge controller is used to regulate the voltage to ensure the battery is safe and can be used for the long term. Without SCC, the battery may be damaged since the SCC function is to control the current from overcharging or draining the battery. Overcharging and severe draining dramatically shorten the lifespan of batteries. This project was to implement the UPS system for the SCC by using the inverter with 1000 W to change the direct current (DC) to alternating current (AC). The 12 V PV solar panel was used in this project to harvest the solar energy and convert it to electrical energy. The battery used in this project is 12 V with 1.2 Ah capacity. The NE556 was used to control the working function of the circuit and the operation of the logic of the circuit while in the simulation using IC 555 because in the Proteus software library, the NE556 was not available but the function was still the same since two IC 555 was equal to one NE556. The result during charging and discharging shows that the SCC can protect the battery from overcharging when the maximum voltage for the battery is around 13.20 V and the current is 0 A while, for the discharging the data taken from the battery and load. When the minimum voltage of the battery reaches around 11.6 V it shows the current load 0 A. In conclusion, this project was accomplished, and the UPS system worked very well when connected to the SCC system.

Keywords: Solar Charge Controller, Uninterruptible Power Supply, NE556

1. Introduction

The two primary types of photovoltaic systems are grid-connected and off-grid, sometimes referred to as stand-alone or isolated solar systems. The grid-connected systems transmit the electricity produced by solar panels using inverters. When it was needed at night or when there was minimal sunlight, the energy was pulled back from the grid. Batteries in separate systems were utilized to power the appliances when the solar panels were unable to produce enough electricity. During the day, batteries are usually used to store surplus electricity. According to the US Department of Energy, about 173000 terawatts of solar energy strike the earth continuously which is enough to power all of our needs. By 2040, Renewable energies will achieve 34% of energy generation worldwide [1]. But there's still a lot most people do not know about solar energy. Thus, the solar energy that is free to used becomes wasted.

In order to make solar energy used at maximum, there must be other technologies that can created instead of only used for housing, building and so on. Why don't use solar energy as the main energy that provides electrical energy for an uninterruptible power supply (UPS)? Given that the UPS is a standalone solar system, it is crucial to have a solar charge controller to prevent harm to the UPS battery. A solar charge controller stops the battery from overcharging by regulating the voltage and current going from the solar panel to it. It was set up as a 15 A/200 W unit and uses MPPT (maximum power point tracking) to increase solar battery charging by up to 30% per day [2].

Solar regulators, also known as solar charge controllers or SCCs, were important components of standalone solar systems [2]. They aim to ensure that the batteries are working as efficiently as possible, particularly by preventing overcharging by turning off the solar panels when the batteries are full and over-draining by shutting off the load when required [3].

Overcharging and severe draining dramatically shorten the lifespan of batteries. Because the battery was one of the costliest parts of a solar home system, it was important to keep it from being overcharged or deeply depleted. A charge controller was essential in this situation to safeguard the battery [4]. The system includes of a solar charge controller, battery, and photovoltaic panel. Batteries were used to store solar energy. The voltage and current flowing from the solar panels to the battery were controlled by a solar charge controller [5]. The battery's charging and discharging were managed by the charge controller, which is a switching device. By doing so, the batteries are protected from harm and have a longer lifespan [6].

An Uninterruptible power supply also known as UPS is a device that can control and convert direct current (DC) energy to alternating current (AC) energy. It produces alternating current due to the action of the inverter circuitry and the input source. The UPS uses a conventional battery with a 12 V rating. Generally, UPS is designed for a small-scale load like a personal computer and it is a basic power rate generated by the UPS. But in commercials, they used the UPS to run their server room in case there is a cut off of electrical power.

2. Materials and Methods

Figure 1 shows the block diagram of the designed solar charge controller. The solar energy charges the solar panel that is connected to the SCC, then the voltage regulator ensures a steady constant voltage supply through all operational conditions. After the voltage was regulated, it was transferred to the solar charge controller circuit to prevent from the battery overcharging since the solar charge controller was connected to the battery. Lastly, it connects to the indicator circuit and load where the indicator circuit is used to indicate the battery condition and the load is the output.

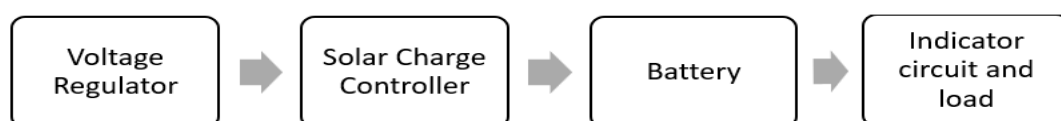

Figure 1: Block Diagram of SCC

Figure 2 shows the block diagram for the whole process of Solar Based UPS system. The 12 V PV solar panel harvests the solar energy and delivers it to the solar charge control (SCC). The SCC energized and charged the 12 V battery. The SCC controls the maximum energy that the battery can store. The SCC stop charging the battery once the battery is at maximum and charge when the battery drops below 12 V. The DC voltage from the battery pass through the DC to the AC inverter to convert the DC voltage to AC voltage and steps up the voltage from 12 V AC to 230 V AC and distribute to the load.

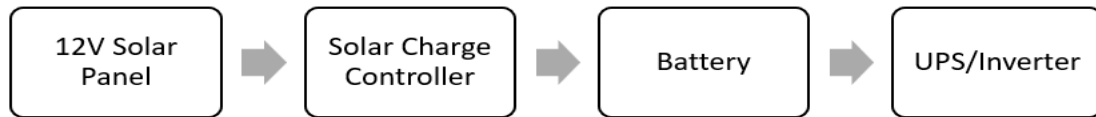

Figure 2: Block Diagram of UPS

The first step of the process was choosing the new project from the main interface of the Proteus 8 software. The designing interface popped up and the next was picking the component from the Proteus 8's library. The process continued until all the components that were needed in this project were chosen. All the components that have been chosen were dragged into the designing interface and the wire was connected to the component. Although the component was connected to the right component and the parameters of the component were changed, the connection of the component was checked to ensure that the component connection was right to avoid errors when running the simulation. The circuit was tested and the result showed whether the simulation was successful or failed because of the error. The hardware design process was proceeded if the simulation was succeeded

Before proceeding with hardware design, the simulation or schematic diagram must be completed and tested to ensure the system can work well. The hardware design discusses how the process of constructing and building the hardware solar charge controller from the software design from scratch and the connection the hardware can be constructed using a Printed Circuit Board (PCB). A PCB is a medium used in electrical and electronic engineering to connect electronic components to one another in a controlled manner. The PCB was designed using the software Proteus and it is based on the schematic diagram. The component of this project was studied and selected based on the similarities of the function as in the simulation. The PCB layout was designed right after the component for this project was determined. The PCB layout was printed after the layout was confirmed. The component was soldered to the PCB layout at the provided and the right place in the PCB. After the component to the PCB, the continuity test was conducted to check the component connection. The solar panel, battery and inverter were connected to the SCC system in order to test the whole system. The data retrieval process can be proceeded if the system test succeeds.

3. Results and Discussion

The results and discussion section presents data and analysis of the study.

3.1 Simulation and Hardware Results

Referring to Figure 3, The circuit is designed based on the use of a timer IC 555 (IC NE556) as the main component that controls the working function of the circuit and the operation of the logic of the circuit. The energy storage part in the circuit used a 12V lead acid battery, while the energy source part used a 12V solar panel. In normal conditions (before the circuit is ON right) assume the battery was fully charged. The first step was to press Run to run proteus and the power supply at Vcc was given to U1 and this IC activated transistor Q1 of the MOSFET power circuit and turned on the load such as a 12V light bulb by showing the LED ON (D15) indicator light up. At the same time, the Ammeter reads the electric current load. The same goes for Figure 4, but the IC used in the simulation was not the same as the prototype. However, this issue was not a problem because basically, the two ICs are

actually the same in terms of function according to the datasheet and only differ from the total number of timers in it, whereas the 555 IC is a normal single type and while the IC NE556 has a CMOS dual IC type in one package, this only makes the IC pins look different in number but the function of the IC was still the same.

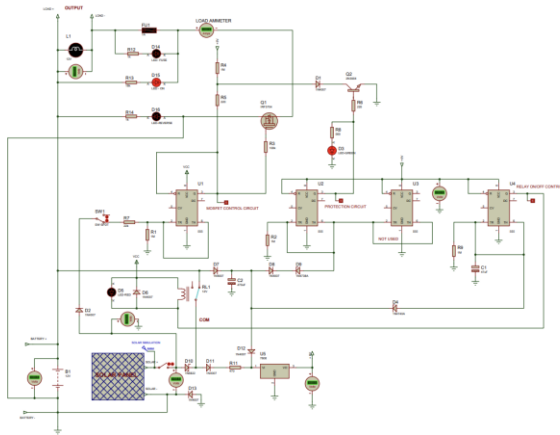

Figure 3: Simulation circuit

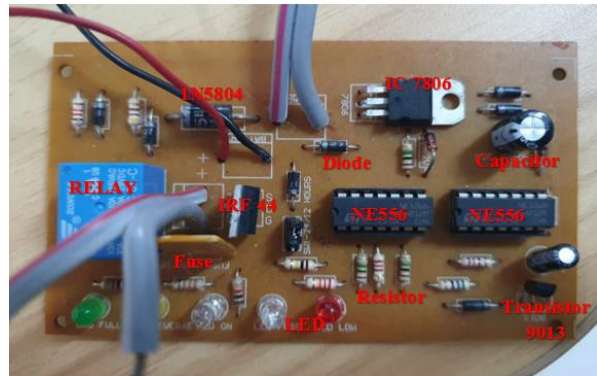

Figure 4: Hardware result

3.2 LED Functionality Test

The LED functionality test was a test to make sure all the LED indicators work well. It was where this project indicates that the battery is in a FULL or LOW state. It also has a function that can show whether the circuit was connected to the power supply or not. This project can show the FUSE condition. Lastly, the reverse polarity indicator, where the LED REVERSE turned on if the connection was in reverse polarity. For the FUSE LED, the result used the simulation by increasing the volt of the battery. This because to avoid the FUSE blow for the prototype. The FUSE can blow because the current and the voltage are too high and damage the fuse. The REVERSE LED from Figure 5 light on due to the wrong connection of the polarity at the battery. Reverse polarity happens when the live and neutral wires are wired in reverse. Reverse polarity can easily be fixed by switching the wires to their corresponding sides. If there were charges in the battery or the prototype had incoming voltage from the solar PV panel, the ON LED lighted up but if there were no charges in the battery or no incoming voltage from the solar PV panel, the ON LED would not light on. Since the FULL LED light was on when the battery was full the ON LED kept turning on. But, for the LOW LED was a difference because, when the battery capacity was low, the LOW LED lighted ON and since it was still connected to the solar panel, the ON LED still lit on but if the solar panel was not connected or no incoming voltage from it and the battery was no charges the ON LED will not light on. Figure 6 and Figure 7 show the FULL LED indicator and LOW LED indicator light on when the battery is at full capacity and low capacity.

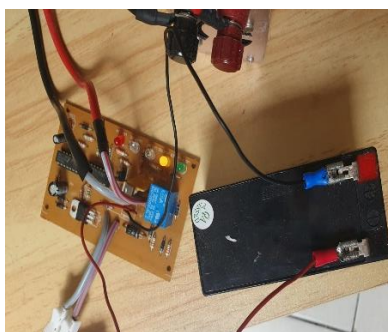

Figure 5: Reverse LED

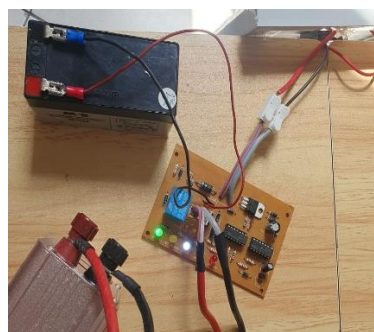

Figure 6: Full LED

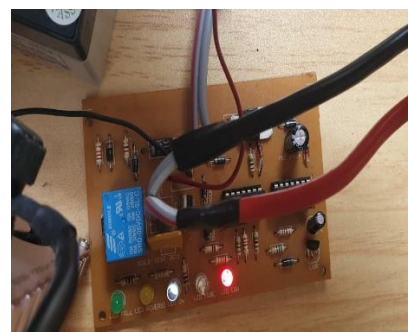

Figure 7: Low LED

3.3 Charging and Discharging Test

The data taken for the charging test was taken from the solar panel and the battery. The solar panel is the input and the battery is the output. The data taken for the charging process for this project was every 5 minutes for 50 minutes. Then, the charging process will continue until the LED-GREEN light indicates the battery is FULL. The load was not connected to the SCC system so that the efficiency of the charging could be increased and the time taken to charge the battery reduced. The time to charge the battery using the prototype was around 11.30 a.m. to 12.20 p.m. Table 1 and Table 2 are the results based on the data taken from the Proteus software simulation and the prototype.

Table 1: Result for the charging phase from the Proteus software simulation

Solar Panel		Battery	
Voltage (V)	Current (A)	Battery Voltage (V)	Current (A)
11.30	0.50	11.5	0.50
11.30	0.50	11.6	0.46
11.30	0.50	11.7	0.40
11.30	0.50	11.8	0.37
11.30	0.50	11.9	0.31
11.30	0.50	12.0	0.26
11.30	0.50	12.1	0.19
11.30	0.50	12.2	0.14
11.30	0.50	12.3	0.05
11.30	0.50	12.4	0.00

Table 2: Result of the charging phase from the prototype

Time	Solar Panel		Battery	
	Voltage (V)	Current (A)	Battery Voltage (V)	Current (A)
11.30 a.m.	10.67	0.19	11.87	0.27
11.35 a.m.	10.45	0.15	11.89	0.27
11.40 a.m.	10.81	0.21	11.91	0.26
11.45 a.m.	10.87	0.22	11.94	0.26
11.50 a.m.	10.96	0.22	11.96	0.26
11.55 a.m.	11.15	0.26	11.99	0.25
12.00 p.m.	11.45	0.31	12.01	0.25
12.05 p.m.	11.27	0.28	12.03	0.25
12.10 p.m.	10.69	0.19	12.05	0.24
12.15 p.m.	11.31	0.29	12.07	0.24
12.20 p.m.	10.65	0.19	12.10	0.24

The data taken for the discharging test was from the battery as input and the inverter as output. This test aim was to test the UPS system whether it can work when there is no incoming voltage source from the solar system. The data was taken for the discharging process every 2 minutes for 20 minutes using a light bulb as the load connected to the inverter. Then, the discharging process will continue until the LED-RED light indicates the battery is LOW and the inverter has stopped working and lights off the bulb. Since the solar PV was not connected to the SCC system, so the time to fully discharge could be taken. Table 3 and Table 4 are the results based on the data taken from the Proteus software simulation and the prototype.

Table 3: Result for the discharging phase from the Proteus software simulation

Battery		Inverter (Load)	
Voltage (V)	Current (A)	Battery Voltage (V)	Current (A)
12.5	0.55	12.4	0.54
12.4	0.54	12.3	0.53
12.3	0.54	12.2	0.52
12.2	0.53	12.1	0.51
12.1	0.52	12.0	0.50
12.0	0.51	11.9	0.49
11.9	0.50	11.8	0.48
11.8	0.49	11.7	0.47
11.7	0.48	11.6	0.46
11.6	0.47	11.5	0.45

Table 4: Result for the discharging phase from the prototype

Time (Minutes)	Battery		Inverter		
	Voltage (V)	Current (A)	Voltage (V)	Current (A)	Inverter Voltage (Vac)
0	13.17	0.33	13.14	0.32	220.50
2	12.67	0.27	12.65	0.26	220.50
4	12.66	0.27	12.64	0.26	220.50
6	12.65	0.27	12.63	0.26	220.50
8	12.64	0.27	12.63	0.25	220.50
10	12.63	0.27	12.62	0.25	220.50
12	12.62	0.26	12.60	0.25	220.50
14	12.61	0.26	12.59	0.24	220.50
16	12.60	0.26	12.58	0.24	220.50
18	12.59	0.25	12.57	0.24	220.50
20	12.58	0.25	12.56	0.23	220.50

4. Conclusion

The summative end is that the project is successfully completed. This project has achieved the objectives which are first to design and construct a prototype system of solar charge controller for the UPS system. The design included the simulation using the software Proteus and from the simulation, this project is able to construct it into a prototype by 12 V PV solar panel used to harvest solar energy. Objective 2 was achieved after doing a simple calculation to determine and recommend the size of solar PV panels which is 6 W and 12 V based on the maximum load demand which is 16 W, battery size used in this project which is 1.2 Ah and 12 V and the inverter size for the SCC system which is 10 W but this project use 1000 W. From the sizing, it can be implemented and able generate the inverter as a UPS system. Lastly, this project was able to evaluate the input and output current for the SCC system and the UPS system which is also the objective of this project. The maximum voltage for input and output for the prototype is 11.45 V and 13.14 V but when the DC current is converted to the AC current, the result shows only 220.50 Vac. The low intermediate circuit DX voltage may cause the under voltage. This can be caused by a missing supply voltage phase from a blown fuse faulty isolator or contactor internal rectifier bridge fault or simply low mains voltage. Besides, the maximum value for the input and output current for this project is 0.31 A and 0.32 A respectively.

Acknowledgement

The authors would also like to thank the Faculty of Electrical and Electronic Engineering, Universiti Tun Hussein Onn Malaysia for its support.

References

- [1] David L. C. (2011, October 2011), Shining Brightly, MIT News
- [2] Korenčiak P., Fiedler P. “Charge Controller For Solar Panel Based Charging of Lead Acid Batteries, Faculty of Electrical Engineering and Communication, Department Of Control and Instrumentation, 2011, Brno University Of Technology.
- [3] Cook G. F. , Solar Charge Controller for Medium Power Applications, February / March 1998,.
- [4] Ashiquzzaman M., Afroze N., Hossain J. M. , Zobayer U., and Hossain M.M. “Cost Effective Solar Charge Controller Using Microcontroller” Canadian Journal on Electrical and Electronics Engineering Vol. 2, No.12, Dec. 2011.
- [5] Ishtiaq A. K., Abid A. S., Navid A. M. , Irin P. S. Saha S. “Design of A Solar Charge Controller for a 100WP Solar PV System” International Journal of Engineering Research & Technology (IJERT) Vol. 2 Issue 11, November.
- [6] Everett M. and Provey J. R. “Convert Your Home to Solar Energy”, (Taunton Press, 2010).