

# Construction of Hexagonal Structures Using a 3D Bioprinter Based on Customized G-Code

S.A. Othman<sup>1</sup>, C.F. Soon<sup>1,2\*</sup>, K.S. Tee<sup>1</sup>, M.K. Ahmad<sup>2</sup>, N. Nayan<sup>2</sup>, N. Sultana<sup>3</sup>

<sup>1</sup>Faculty of Electrical and Electronic Engineering,  
Universiti Tun Hussein Onn Malaysia, Johor, 86400, MALAYSIA

<sup>2</sup>Biosensor and Bioengineering Laboratory, Microelectronic and Nanotechnology-Shamsuddin Research Centre (MiNT-SRC),  
Universiti Tun Hussein Onn Malaysia, Johor, 86400, MALAYSIA

\*Corresponding Author

DOI: <https://doi.org/10.30880/ijie.2021.13.02.025>

Received 1 January 2020; Accepted 3 December 2020; Available online 28 February 2021

**Abstract:** Three-dimensional (3D) bioprinting is adopted from the existing technology of 3D printing that is able to recreate the microenvironment of tissue structures or organs. However, the existing printing mechanism is normally based on slices of a 3D structure in computer-aided slicer software and prints in horizontal and diagonal manners. Such printing mechanism involving soft bioink which does not polymerise in short period of time produces distorted constructs due to the thixotropic properties of the bioink. To circumvent this problem, G-codes for simple 3D bioprinting mechanism were derived. A 3D bioprinter has been developed to implement unidirectional printing for different concentration of bioink. The modified coding was successfully customized for printing single layer to multilayer hexagonal structures. Additionally, the dimension accuracy of the 3D printing in producing similar dimensions of a design in CAD software is highly dependent on the concentration of the bioink applied. The results show that up to 97 % of printing accuracy can be achieved by applying 10: 50 % v/v of alginate/gelatin bioink.

**Keywords:** 3D Bioprinting, G-codes, hexagonal structures

## 1. Introduction

Three-dimensional (3D) bioprinting technology offers a new approach for fabricating functional tissues or organs. It involves additive manufacturing technique in printing tissue or organ constructs by depositing layer by layer of natural or synthetic polymers according to the computer-aided (CAD) design [1]. It can be used in various biomedical applications including tissue engineering and regenerative medicine, pharmaceutical screening, transplantation and cancer research [2]. Due to its significant potential in regeneration, it closely resembles microarchitecture of the native tissues, as 3D bioprinting has become the growing trend in biomedical engineering field [3].

Generally, 3D bioprinting process applies computer numerical control (CNC) printing mechanism similar to the existing 3D printing technology except with an inclusion of biological materials. Most of the existing CNC machines, such as 3D printer, require specific commands or G-codes to control the operation. The controller is linked to the x, y and z linear guides with stepper motors moved to the precise location and laid down successive layers of polylactic acid (PLA) or Acrylonitrile Butadiene Styrene (ABS) filaments via the extrusion head. The existing 3D printer prints thinly sliced horizontal cross-sections of a CAD model repetitively until it creates the designed object structure [4].

Most of 3D printings are produced in diagonal movement to produce solid structures. The temperature of the extruder, temperature of the heating bed, XYZ coordinates for printing, extrusion rate and extruder moving speed are

written in the G-code of the 3D slicer software such as CURA, 3D slicer, simplify3D and Pathio. However, the diagonal printing mechanism is not suitable for producing a cylindrical structure with thin wall in 3D bioprinting. The existing printing mechanism [5] based on the 3D slicer software is more suitable for printing complex structures and less suitable for bioprinting process due to the viscoelastic properties of hydrogel or bioink. In this study, the steps to design uni-directional G-codes for producing simple structures are introduced. The G-codes are used to print single and multilayer hexagonal structures in uni-direction. Prior to printing, G-codes are simulated in numerical control (NC) viewer online software to predict the designed printing mechanism. The difference in terms of length between the design and printed structure is measured to compute the accuracy of the bioprinter. In this experiment, a simple self-made microextrusion-based bioprinter was designed. The bioink consists of a mixture of alginate and gelatin at different concentration. This study demonstrates a simple designed mechanism that will suit bioprinting hexagonal structures.

## 2. Illustrations

### 2.1 Hardware Development of Microextrusion-Based 3D Bioprinter

In this project, there were three major parts involved in the development of a 3D microextrusion-based bioprinting system. The model parts were divided into controller, extruder machine and a commercial 3D printer (Prusai3, Czech Republic). Figure 1 illustrates the conceptual model of 3D bioprinter that was designed using Google SketchUp 2017 software (Trimble Navigation Limited version 2017). The controller board was equipped with on/off, infusion, diffusion and bioink feed rate selection buttons. The motorised extruder machine consists of a syringe holder to hold the syringe in place and a plunger holder. In this design, the tip of the syringe was connected to the print head of the 3D printer with a silicon tube. The bioink was loaded in the syringe to be extruded via a silicone tube. A glass slide was put on the 3D printer stage for laying out the structure to be printed using the bioink.

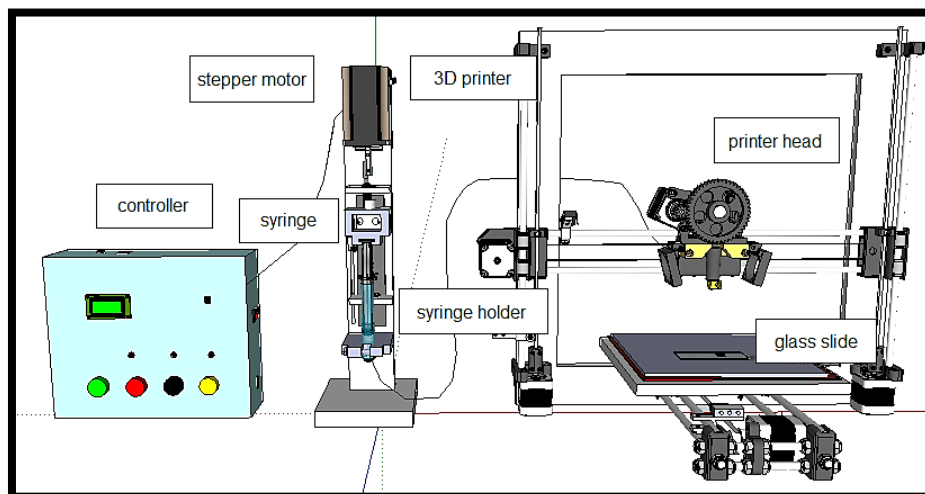

**Fig. 1 - Conceptual model of a micro extrusion-based 3D bioprinting system**

Figure 2 shows the block diagram of the 3D bioprinting system. Arduino Mega 2560 was used as the microcontroller that provided instructions to the Liquid crystal display (LCD) and the motor driver. A 16x2 LCD displayed the menu for setting the flow rates and diffusion status. The slider moved the plunger in and out of the syringe based on the selections. A pipette tip connected to the silicon hose linked to the extrusion syringe pump was attached to the printing head of the 3D printer. The pipette tip was subject to the movement in Z-direction, while the X-Y table moved at the bottom of the tip.

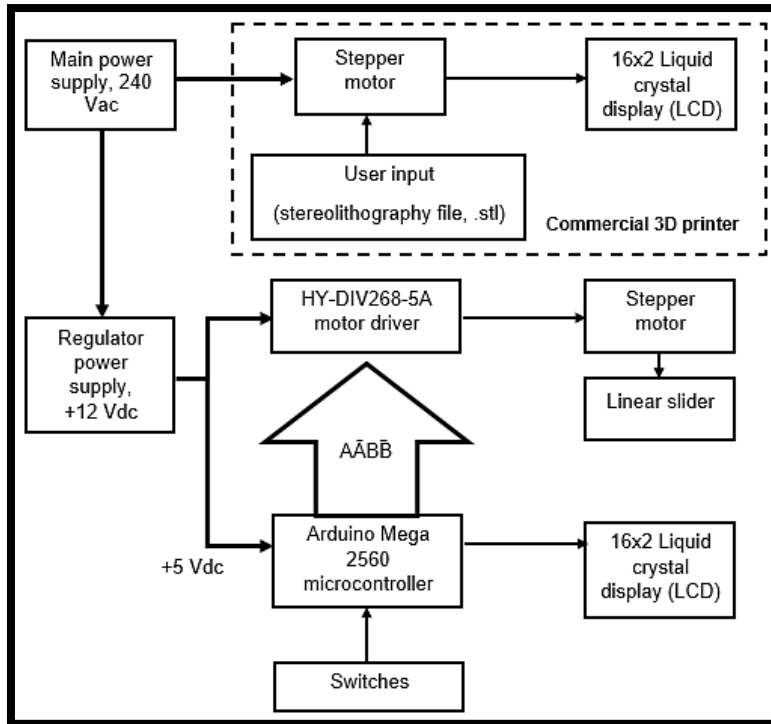

Fig. 2 - Block diagram of overall bioprinting system

## 2.2 Structures Design

A 2D structure was created in the Inkscape software version 0.92.3. Similar G-codes for 2D structure were stacked in the Z-axis, forming into G-codes which produced a 3D structure. Then, the design was converted into a G-code file. The G-code was simulated and verified using the NC Viewer 2018 software. The code can be modified to ensure that the bioprinter printed according to the intended direction and not diagonal direction, such as those G-codes produced by the existing slicer software. After the modification, the file was saved into an SD card used for 3D bioprinting. The design of the desired structures was designed in Inkscape 0.92.3 software. The software allows structures to be designed in a simple way either in two-dimensional shape (2D) or three-dimensional (3D) structures by converting the drawing into G-codes. Figure 3 shows an example of basic design in the software for uni-directional printing. The design was then converted into a G-code file. For 3D bioprinting, a 2D drawing was produced and converted into G-codes. Based on the G-codes of a 2D drawing, the codes were modified for Z-axis, and reiterated for producing a 3D object.

NC Viewer 2018 (Xander Luciano version 1.1.3) software was used as a G-code editor to verify CNC codes or 3D digital files. The G-code editor offers a three-dimensional view of the final product along with the coding. In this research, it was used for the simulation of the design extracted from G-code files.

## 2.3 Bioink Preparation

Sodium alginate (Sigma-Aldrich, Dorset, United Kingdom) was dissolved in deionized (DI) water to make 10% of sodium alginate solution. Gelatin solution (Sigma-Aldrich, Dorset, United Kingdom) was prepared by dissolving Gelatin powder in the DI water and heated to 65°C. Gelatin was prepared in 10%, 20%, 30%, 40% and 50%, which was loaded into 5ml syringe, respectively. The bioink was prepared by mixing different concentrations of gelatin with a fixed 10% of alginate in a 50ml polypropylene tube.

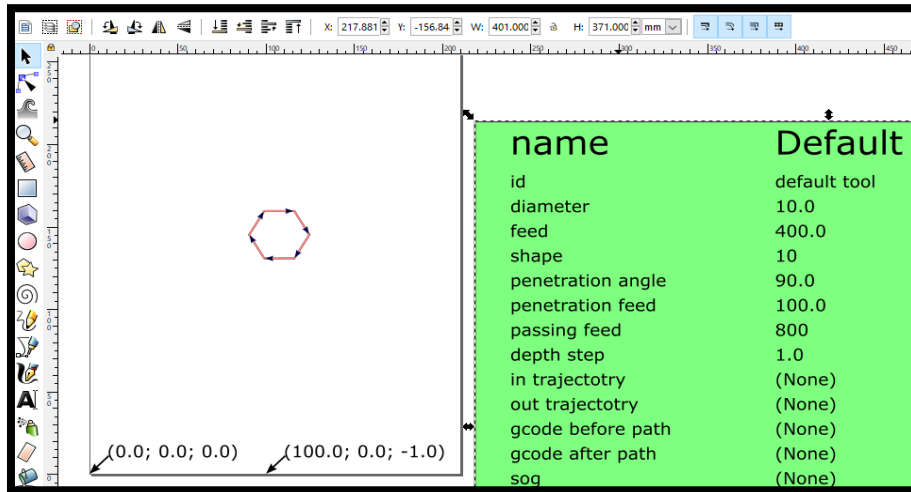

Fig. 3 - Basic two-dimensional hexagonal shape design in Inkscape software

## 2.4 Dimension Accuracy of 3D Bioprinting

Dimension printing accuracy is crucial in order to understand the bioink behaviour as well as its ability to replicate the designed shape. A single layer of hexagon structure was designed and printed via a pipette tip with a diameter of 1 mm of the bioprinter. The structure was printed by using different concentrations of alginate/gelatin bioink. Five different percentages of concentration ranging from 10:10% v/v, 10:20% v/v, 10:30% v/v, 10:40% v/v to 10:50% v/v of alginate/gelatin bioink were used to observe the printing accuracy associated with each different bioink concentration. The printed images were captured by using electronic digital microscope. Then, the images obtained were analyzed using ImageJ to find the differences in diameter of the CAD design structure,  $D_a$  (mm) and the printed structure,  $D$  (mm). All the results with different alginate/gelatin concentrations were analyzed using ImageJ. The experiment was repeated three times. The accuracy of the printing dimension was calculated with reference to the  $D_a$  in the CAD software using equation (1):

$$Accuracy (\%) = \left[ 1 - \frac{|D_a - D|}{D_a} \right] \times 100 \quad (1)$$

## 3. Results and Analysis

### 3.1 G-Codes Simulation Results for Multilayer Printing

Figure 4 (a) shows the coding or G-code obtained from Inkscape software. In the G-code, header is important to initialize the printer. It usually contains the code to control the speed of spindle of CNC machine and unit for the printing scale such as millimetres (mm). The header is followed by the G-code of the desired design as shown in Figure 4 (a) and (b). This coding was implemented to move a CNC machine from early position to the specified position according to the X, Y and Z axes. The footer in the G-code stopped the printer movement, and ended all of the printing process. In this experiment, an in-house microextrusion-based 3D bioprinter (figure 1) was used to print the biomaterial components. G00 was used in the coding for rapid linear motion to the destination point of coordinated x, y and z-axes. G01 was for the linear feed to ensure it moved in a straight line. In the G-code, M3 was used to start the turning of spindle. To end the printing process, M5 was called first to stop the spindle and M2 to completely end the programs. From the coding in Figure 4 (a), similar G-codes generated by Inkscape software were adopted with a modification of the Z-axis codes (figure 4 (b)) to produce multilayer structures (Figure 4 (d)).

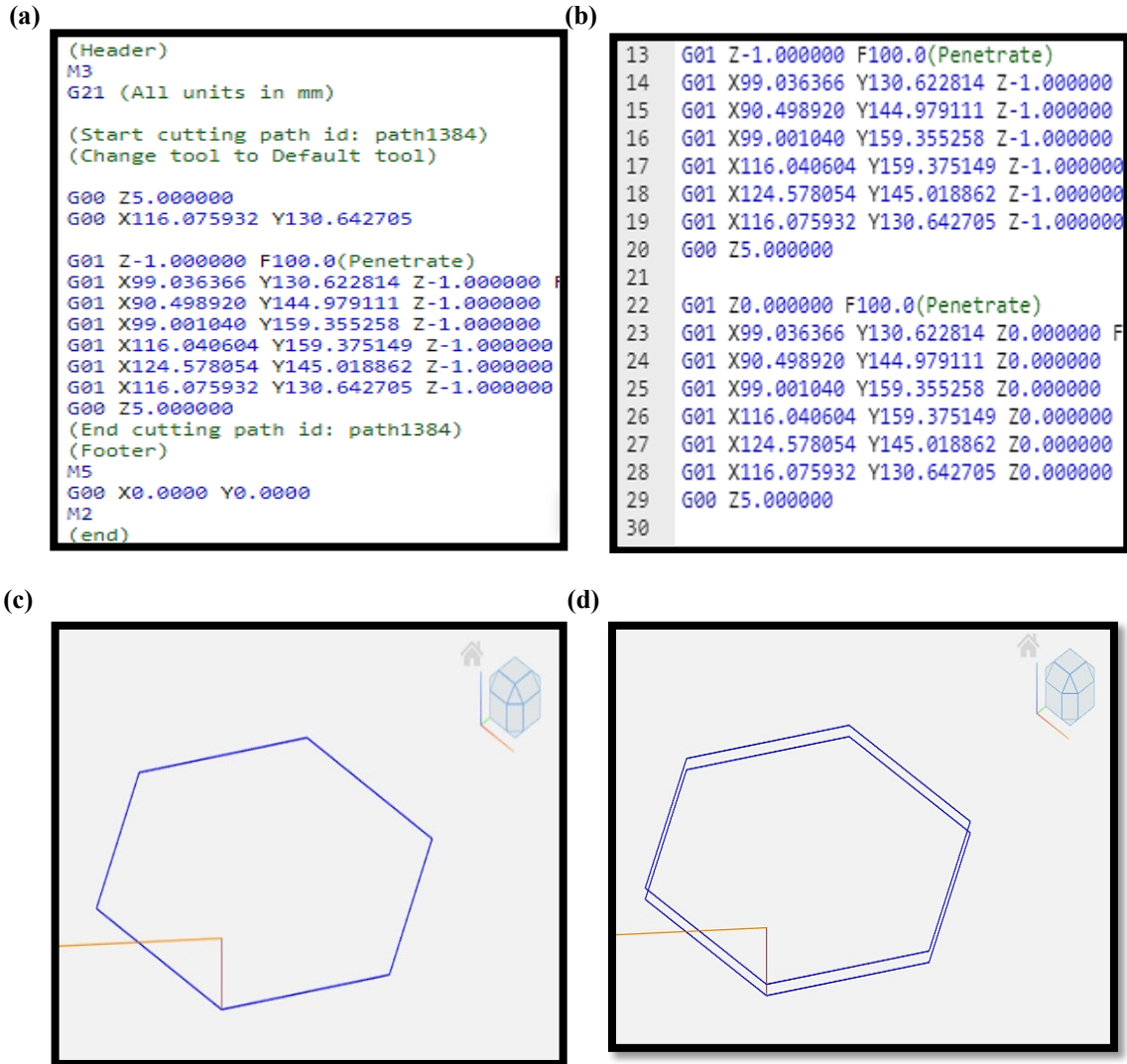

Fig. 4 - G-code for (a) single; (b) multilayer structures, respectively. NC viewer simulation for; (c) single layer hexagonal structure; (d) two layers of hexagonal structure obtained by changing the Z-axis

### 3.2 3D Bioprinting Verification

The first printing test conducted was to print a single layer hexagonal structure with continuous strand of alginate/gelatin bioink using a tip of 1 mm nozzle size attached to the bioprinter head. In this experiment, the extrusion rate used was 1 ml/min and the printer head z-offset was fixed to 1 mm from the petri dish. The test continued with printing a multilayer structure comprised of two layers. Figure 5 (a) is the example of hexagonal structure printed using the existing 3D slicing mechanism. The slicing technique in diagonal and horizontal manner caused the soft hydrogel to stack non-uniformly and created distorted structure. Thus, in this project, the mechanism proposed was more suitable for printing soft hydrogel. The results in Figures 5 (b) and 5 (c) showed the output based on the customized G-code. The bioprinter head moved according to the path designed as described in section 2.2. Figure 5 (b) displays the printing results of single layer, while Figure (c) shows the printed multilayer structure. The hexagonal structures represented the hollow tubes such as blood vessels and air pipe in our physiological system.

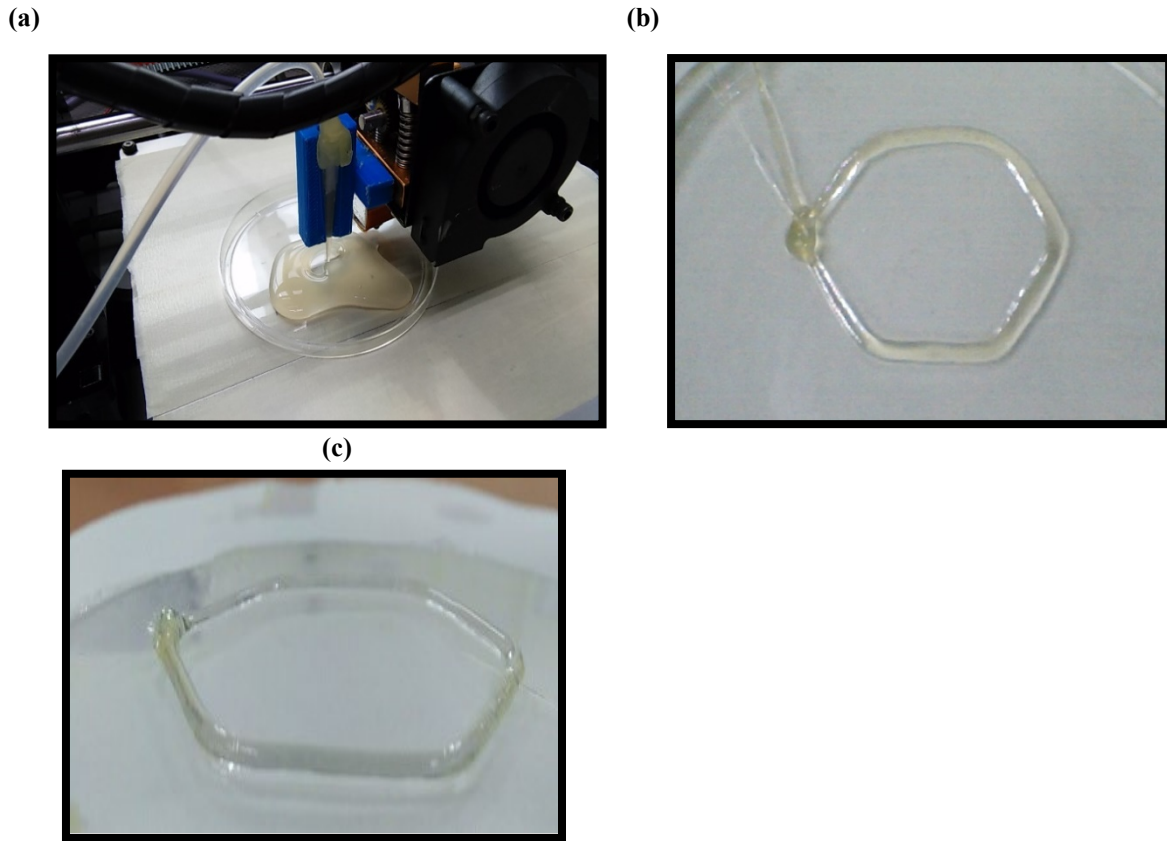

Fig. 5 - (a) An example of construct printed based on 3D slicing printing mechanism; (b) printed hexagonal construct of single layer; (c) Two layers of printed hexagonal constructs based on customized G-code

### 3.3 Dimension Accuracy of Printed Construct

The diameter measured in Inkscape software is as shown in Figure 6 (a), while figure 6 (b) shows the image of 3D printed structure using a 3D bioprinter. A bioink of 10:50% v/v was used to print an accurate structure as shown in Figure 6 (b). The average of the printed dimension is shown in Table 1.

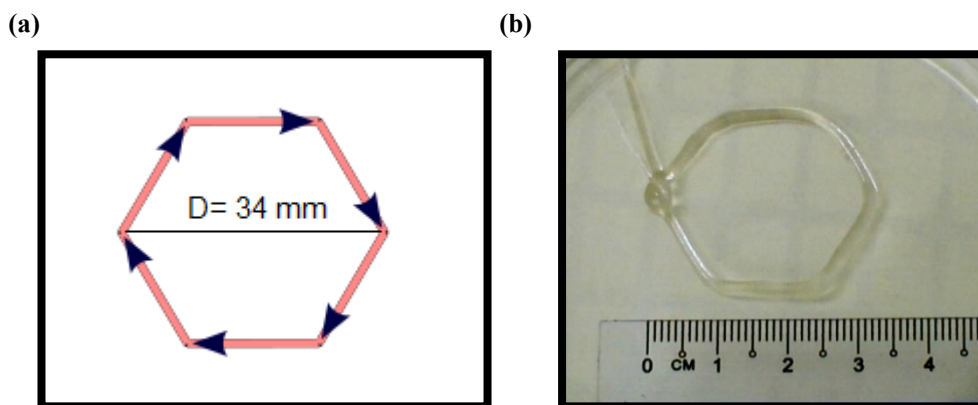

Fig. 6 - (a) Image of single layer measured in Inkscape; (b) Image of the printed single layer by using 10:50 % v/v alginate/gelatin bioink

However, Figure 7 indicates that there is a significant discrepancy between original CAD design and printed structure in the dimension of printing when the concentrations of the hydrogels varied for the bioink. The alginate solution included in the bioink was fixed to 10% v/v, whilst the concentration of gelatin varied from 10% v/v to 50% v/v. Figure 7 shows that printing accuracy increased proportionally with the bioink concentration in which concentration was associated with the viscosity of the bioink. At higher concentration of the composite alginate/gelatin bioink (10:50% v/v), the printed

dimension of the structure yielded the highest accuracy of 97% similar to the designed dimension. In bioprinting process, the concentration of the composite bioink played an important role in determining the accuracy of the printed structure. Alginate and gelatin hydrogels are thixotropic materials that experience shear thinning behavior when these materials are extruded from the nozzle of the pipette tip.

Previous research [6] shows that increasing the alginate concentration is able to produce high printing accuracy, but no significant changes to accuracy in increasing gelatin concentration (6% to 8%). At lower concentration of bioink, it experienced minor shear thinning that slightly reduced the size of the hexagonal structure. Lower concentration of the bioink that behaves with lower thixotropic property is not suitable to produce biostructures that requires high accuracy such as a blood vessel. This is because the printing accuracy degrades to 58% at a gelatin concentration of 10%. Thus, the bioink concentration is one of the factors that contributes to accuracy of the 3D bioprinted structures that need to be carefully considered for printing tissues that require high accuracy.

**Table 1 - Percentage of accuracy**

| Gelatin Concentration (%v/v) | Designed dimension (mm) | Printed dimension (mm) | Percentage of Accuracy (%) |
|------------------------------|-------------------------|------------------------|----------------------------|
| 10                           | 34                      | 19±0.58                | 57                         |
| 20                           | 34                      | 22±0.58                | 64                         |
| 30                           | 34                      | 25±0.58                | 75                         |
| 40                           | 34                      | 28±0.52                | 84                         |
| 50                           | 34                      | 33±0.29                | 97                         |

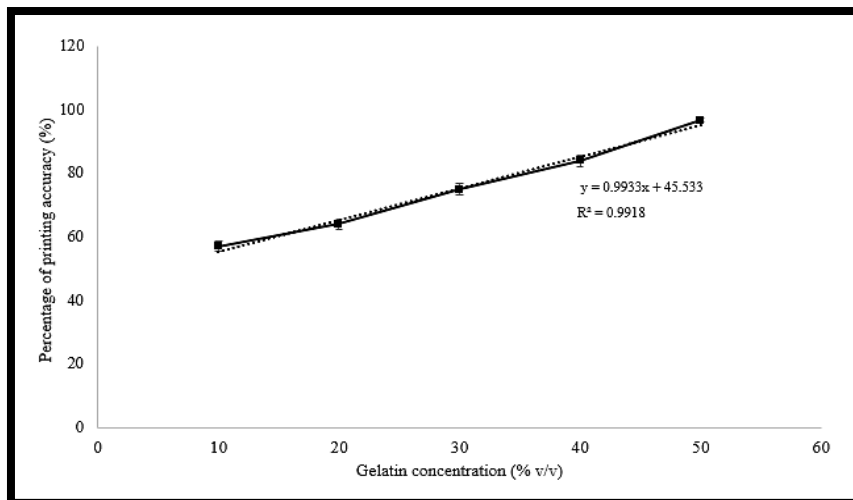

**Fig. 7 - The effect of different gelatin concentration on printing accuracy at a fixed concentration of 10 % v/v alginate**

#### 4. Conclusion

The designing of structure and programming G-codes are crucial in contributing to the smooth startup of the printing process. Most of the 3D printing CAD softwares are more complex and difficult to be tailored for the bioprinting process. The self-made bioprinter successfully prints single and multilayer constructs. In this paper, the printing mechanism is proposed with only few simple steps which successfully print single and multilayer hexagonal constructs. The modified G-codes are able to overcome the problem of existing printing mechanism produced by the G-code of slicer software. The results also successfully demonstrate multilayer structure can be printed by changing the Z-axis in the G-code. The accuracy in printing a 3D structure depends on the concentration of the bioink. The printing of alginate/gelatin constructs is able to achieve up to 97% of accuracy.

#### Acknowledgement

This project is funded by Ministry of Education Malaysia under Fundamental Research Grant Scheme (FRGS) with a reference number of FRGS/1/2018/STG05/UTHM/02/3 or FRGS Vot No. K106. The authors also acknowledge the support from Faazahana Mohkter and Ahmad Nasrull Mohamed for their technical assistance.

## References

- [1] K. Hölzl, A. Ovsianikov, S. Lin, L. Gu, L. Tytgat and S. Van Vlierberghe, “Bioink properties before, during and after 3D bioprinting,” *Biofabrication*, vol. 8, pp. 032002, 2016
- [2] A.M. Holmes, A. Charlton, B. Derby, L. Ewart, A. Scott and W. Shu, “Rising to the challenge: Applying biofabrication approaches for better drug and chemical product development,,” *Biofabrication*, vol. 9, pp. 033001, 2017
- [3] W. Peng, D. Unutmaz and I.T. Ozbolat, “Bioprinting towards physiologically relevant tissue models for pharmaceuticals,” *Trends Biotechnol.* 34 722–732, 2016
- [4] S. Mueller, S. Im, S. Gurevich, A. Teibrich, F. Guimbretière and P. Baudisch, “WirePrint: Fast 3D Printed Previews,” *Proc. UIST*, pp 273–280, 2014
- [5] Jing Hu, “Study on stl-based slicing process for 3d printing,” *Solid Free. Fabr.*, pp 885–895. 2017
- [6] M. Di Giuseppe et al., “Mechanical behaviour of alginate-gelatin hydrogels for 3D bioprinting,” *J. Mech. Behav. Biomed. Mater.*, vol. 79, pp. 150–157, 2018