



A Review on the Development of Panel and Membrane Sound Absorbers

Nur Izzah Hamdan^{1*}, Muhd. Hafeez Zainulabidin¹, Al Emran Ismail¹,
Angzzas Sari Mohd Kassim²

¹Faculty of Mechanical & Manufacturing Engineering,
Universiti Tun Hussein Onn Malaysia, 86400 Parit Raja, Batu Pahat, Johor, MALAYSIA

²Faculty of Engineering Technology,
Universiti Tun Hussein Onn Malaysia, 86400 Parit Raja, Batu Pahat, Johor, MALAYSIA

*Corresponding Author

DOI: <https://doi.org/10.30880/ijie.2021.13.01.007>

Received 25 November 2019; Accepted 11 November 2020; Available online 30 January 2021

Abstract: Noise pollution has become one of the most serious environmental problems, especially in developing countries. Noise pollution caused discomfort, dizziness, and continuous exposure to an excessive amount of it affects human health both physically and psychologically. The utilization of sound absorption material has become an effective solution in reducing or controlling this noise pollution problem. Panel and membrane material getting more attention because of its effectiveness in absorbing low-frequency sounds, more hygienic and safer to human health compared to the porous material. Therefore, the panel and membrane absorbers have been developed rapidly in various fields and also have evolved to become more designable, advanced, and efficient in absorbing sound. However, combinations of membrane or panel absorber with porous materials are still advantageous in term of sound absorption performance and even worth considering. This paper aims to provide an information and literature study on panel and membrane absorbers evolution in the past decades in terms of improving the sound quality. This paper also covers the introduction of panel and membrane sound absorption system, variations of panel and membrane absorber concepts, and factors affecting the absorption performance of the materials. From the review, material properties such as mass density, air cavity, thickness, and perforation found to influence sound absorption performances. By looking at the intensity of research and progress of panel or membrane absorber, it is predicted that there will be more development and improvement of panel and membrane absorbers. Therefore, it is essential to review the progress and development of the panel and membrane absorbers to give a better understanding of their absorption characteristics and to seek new research opportunities in the future.

Keywords: Membrane, panel, sound absorbers

1. Introduction

Today, acoustics has become an essential consideration in architectural design. The architects have realized that the architectural environment needs an excellent acoustics design to create a pleasing living or working atmosphere. An excellent architectural acoustic design enhances the quality of sound and improves the speech intelligibility in the enclosed spaces. In general, the sound level in the enclosure depends on the total sound absorption and reflection. A small room or areas with no absorbing surface reflecting the sound energy and generates disturbing echoes, which take a while to disappear. In the meantime, architects and acoustics engineers are trying their best to overcome this acoustics problem. Later, they found a very efficient solution by installing sound-absorbent materials. The sound absorptive

material able to reduce the sound propagation and shortens the reverberation time by converting sound energy into heat energy without decreasing the aesthetic value.

Three common types of sound absorbers are porous absorber, Helmholtz absorber, and panel or membrane absorber. Porous or fibrous materials are the most popular and often used in architecture because of its impressive achievement in absorbing sound at low cost compared to other absorbers. For more than a decade, synthetic fibre has been used as a porous absorber material. However, it raises public concern when it comes to hygiene and health issues. Therefore, it gives an idea to the researchers to search for an alternative solution, and the results lead to the utilization of natural fibre. According to several studies, natural fibre is more eco-friendly, safe, and good in absorbing sound energy [1-5]. However, even with the amazing characteristics, porous absorbers are still inefficient at low frequencies.

In architectural, the absorption of low-frequency sound is needed, especially in an enclosure, which is hard to accomplish by using conventional porous materials. Therefore, the attention begins to shift toward panel or membrane absorber. Panel or membrane absorbers are known to have the capability of absorbing sound at low-frequency range and can be an excellent solution to overcome this problem. Recently, the applications of membranes are increasingly popular in interior spaces due to their aesthetic and ergonomic features. Roof and ceiling are examples of highly demanded membrane building structures. Membranes are known to be light, durable, easy to be constructed, flexible, translucent, and aesthetic appeal. Because of all these features, membranes are suitable for numerous applications, including acoustical purposes. Previously, the lightweight painted canvas and rubber sheet membrane have been used in auditoria as a sound reflector. In the early publication, Hashimoto [6] have discovered a promising concept for membrane structure such as dome by using membranes with additional weights. Membrane with additional weight found to have good sound insulation performance in low frequency with light transmissibility. Fig.1 shows the example of a possible application of membrane with additional weight in membrane structures proposed by the author.

More than a decade, various types of membrane and panel absorber structures have been developed and studied due to their incredible characteristics and potential. Now, the investigations on the performances of both absorbers are still on going. The purpose of this paper is to review the progress and development of membrane and panel absorbers. Factors that influencing the acoustic properties of panel and membrane absorber also will be further discussed.



Fig.1: Example of framed membrane structures [6].

2. Panel and Membrane Sound Absorption Mechanism

The sound absorption of the panel or membrane is a mass-spring resonance system which mass vibrates against spring. The sound absorption mechanism of the panel or membrane absorbers is dissipating the energy through the vibration. When the acoustic energy hits the surface, the vibrating sheet acts as a mass and the cavity of an enclosed space acts as a spring. In general, panel or membrane absorbers are placed over an air cavity with some distance from the solid backing. Fig.2 shows the schematic diagram of the panel and membrane backed by a rigid wall with an air gap in between.

Typical panel absorbers are produced from a thin sheet of non-porous material such as wood, metal plate, plastic board, and plasterboard. For membrane absorbers, it is commonly made from lightweight, flexible materials, stretched and mounted over a rigid support. Most of the time, membrane absorber is frequently used as a term to describe a sound absorption method instead of referring to the resonator type utilized [7].

The performance of the panel or membrane absorber can be predicted by using an equation of the impedance of membrane backed by a cavity written as [7]

$$Z = j \left(\omega m - \frac{1}{\omega C} \right) + R_m \quad (1)$$

Where ω is angular frequency, m is membrane mass per unit area, C is speed of sound and R_m is mechanical losses of mounting. The resonance frequency, f_r of the material backed by a rigid wall can be found by

$$f_r \approx \frac{6.0}{\sqrt{md}} \quad (2)$$

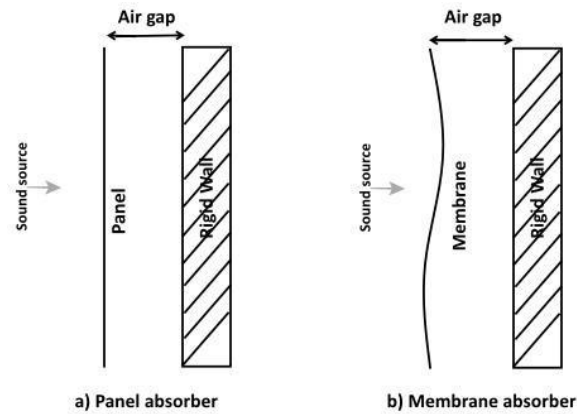

Fig.2 - Geometry diagram of panel and membrane absorber backed by a rigid wall

3. Development of Various Membrane and Panel Absorbers

3.1 Panel and Membrane Absorber

In the beginning, membrane type of absorber was utilized to cover and protect porous absorbent material from contamination. Subsequently, it has been found to have a significant effect on the absorption performance. The absorption frequency range of porous absorber affected by the thickness of the covering layer and this statement supported by Schwartz and Buehner [8], where they were among the earliest that discovered the thin covering membrane improves the porous absorber absorption characteristics. Afterwards, a significant development in the modelization of layered porous material with the impervious membrane has been developed by Bolton [9].

In development of prediction method of membrane or panel, Ford and McCormick [10] theoretically predicted the acoustic behaviour of the square panel constructed without protective covering. An equation motion of thin plate with clamped edges was presented to describe the variation of panel absorber in normal incidence. The author's prediction theory has been used by others in their research to analyse the low frequency absorber system. Fuchs [11] also continues to study the behaviour of square plate absorber acoustically and discovered the increases in the panel mass and the air cavity thickness able to give excellent absorption at low frequencies. These findings also mean that the additions in the panel mass and the thickness of the air cavity will cause extra cost and takes a lot of space in a particular room. However, Fasold and Veres [12] have studied that the thickness of the cavity depends on the absorbed wavelength of the sound wave. Therefore, the air cavity thickness must be carefully selected.

In general, the layered porous materials with impervious screen need to be thick and bulky in size to be efficient in medium and low frequencies. The presences of porous materials are also not suitable in the environment that requires high hygiene restrictions such as hospitals, food industries and even micro-electronic industries. Therefore, several researchers have conducted new studies to develop membrane or panel absorber without porous materials. Kang and Fuchs [13] in their work present a theoretical method for predicting the combination of membrane absorber with micro-perforated absorber by using the equivalent circuit, assuming the membrane and the opening are being connected in parallel as illustrated in Fig.3. Their study showed that the combination of the mentioned structures with proper parameter adjustment able to make the sound absorption coefficient higher without the need of porous material and also widen the frequency range by doubling the layer of the same material.

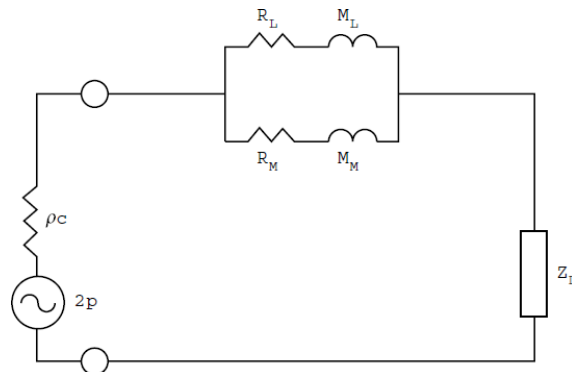

Fig. 3 - The equivalent circuit of micro-perforated membrane absorber [13]

The acoustic properties of an infinite elastic plate with a backed cavity had been theoretically determined by Sakagami *et al.* [14]. The purpose of their research was to investigate the effect of air cavity on the panel sound absorption. Their absorption characteristic prediction theory also can be applied to membrane problems. The authors then made some modifications from the previous paper and introduced an analytical solution for the absorption coefficient of an infinite cavity-backed membrane [15]. Based on the analytical solution that has been introduced, it can be used as a reference in designing a membrane or panel type absorbers. Takahashi *et al.* [16] then analysed the acoustic properties of permeable membranes. They later develop a sound absorption theory for a single-leaf permeable membrane. Subsequently, Sakagami *et al.* [17] carried out an in-depth study from the previous work [16] to clarify the effect of permeability and other material parameters on membrane acoustic performance using an equivalent circuit analogy. According to the authors, the sound absorption at high frequencies improved by the permeability of the membrane and, the result shows that the membrane with optimum flow resistance more efficient in absorbing sound.

Due to the favourable results of the single leaf permeable membrane, the number of leaves has been multiplied [18-20]. The multiple leaf membrane shows a promising result compared to the single leaf. These series of studies were intended to study more about their acoustic properties. Consequently, the theories able to predict the acoustic properties of the membranes and the predictions also have been verified experimentally. A permeable membrane also can be used as an alternative in a double-leaf micro-perforated panel (DLMPP). DLMPP found to have broadband sound absorption. However, MPP itself is very expensive, and doubling the leaf means doubled the cost. Replacing the second leaf of DLMPP with permeable membranes could be a better solution due to the effectiveness of the permeable membrane in absorbing sound and also inexpensive compare to DLMPP.

Apparently, the substitution of permeable membrane shows better absorption at high frequencies and improves the sound absorption performance of MPP [21-22]. Two structure of MPP with permeable membrane were also investigated as shown in Fig 4. The result indicated that the MPP on the outer side have broadened and increasing the absorption peaks with wider range of frequency than conventional DLMPP. Meanwhile, when PM placed on the outer side shows high absorption at high frequency range, similar with porous blanket.

Since all of the previous studies assume the air backed cavity is in uniform depth, Sakagami *et al.* [23] come out with an idea to investigate the sound absorption characteristics of panel absorber with a non-uniform depth of air-backed cavity. It is found that the non-uniform cavity has a broader absorption peak compared to the uniform depth cavity. The study also shows that the theory of panel absorber with a uniform cavity can be used to define the absorption characteristics of the panel absorber with a non-uniform depth cavity.

A recent study by Sakagami *et al.* [24] involved an investigation of permeable membranes without a back wall known as a space absorber. These space absorbers can be advantageous in a condition where there is no rigid backing against the permeable membrane. The space absorber can be placed on the floor as a sound-absorbing partition, hung on the ceiling or any places in interior buildings. In the latest publication, the authors also proposed a three-dimensional space absorber using permeable membranes, where the space absorber can be easily put in any places, including small spaces. Fig. 5 shows the schematic diagram of cylindrical and rectangular permeable space sound absorber. The result from the study shows that cylindrical shape absorber has a better absorption coefficient compared to the rectangular shape at low frequencies [25-26].

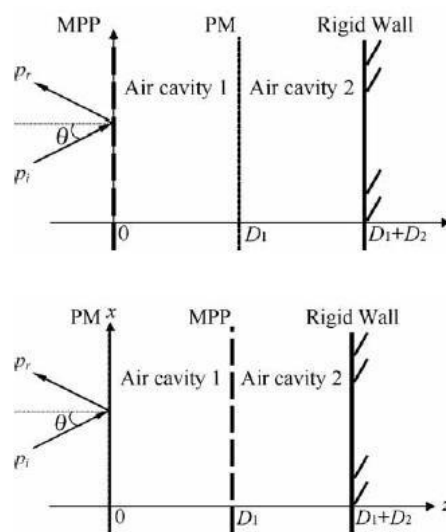

Fig. 4 - A schematic diagram of MPP and permeable combination, (Top): MPP on the outer side with permeablemembrane (PM) in the cavity. (Bottom): PM on the outer side with MPP in the cavity[21]

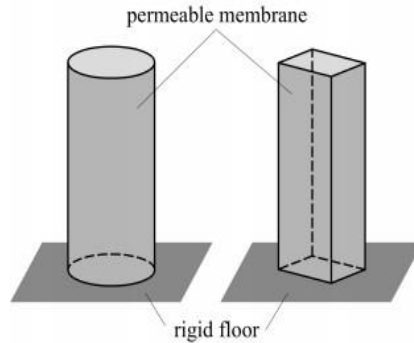

Fig. 5 - Schematic diagram of the cylindrical and rectangular permeable membrane space sound absorber [26]

3.2 Perforated Panel Absorber

A panel absorber with a relatively small opening produced a Helmholtz resonators type absorber and called as perforated panels. Helmholtz resonators have two principal forms, namely single resonators, and array resonators. The perforated panel used in a room and duct silencer is an example of an array resonator that consists of many individual Helmholtz resonators. Both forms of Helmholtz resonators have similar characteristics, which have a cavity and a small opening that allow the sound energy enters the cavity as illustrated in Fig.6. The perforated panel absorption is also related to the mass-spring-damper system. The air around the neck or aperture will act as mass and the air in the cavity act as a spring. The springiness of the air inside the cavity causes the mass around the opening area to vibrate and converted the sound energy into heat.

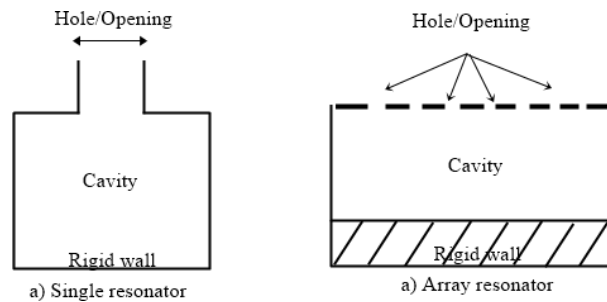

Fig. 6 - Two principal form of Helmholtz Resonator

The perforated panel often used as a support or protective layer of porous materials due to its low sound absorption performance and its dependency on the porous material inside. This perforated panel can be adjusted to absorb sound at a given frequency band by carefully changing its backed air cavity distance, perforation size or neck, perforation ratio, and thickness [27]. The mentioned dimension also plays a role in controlling the resonance frequency. Nevertheless, a perforated panel has small absorption bandwidth and only useful in absorbing sound at low frequency. However, they are advantageous for some applications or areas that require low-frequency absorption without the need to increase the material thickness as required by porous absorbers. This type of Helmholtz resonator is widely used in a ducting system due to its inexpensive cost, durable, and practical for low-frequency duct-borne noise control. Many types of research with a variety of ideas trying to improve the absorption performance of the Helmholtz resonator by altering the orifice neck or shape, including proposing various kinds of perforated plates model

In the development of prediction method for perforated panel, Bolt [28] was the earliest to theoretically investigates the perforated facings and predicts the acoustic impedance of perforated facing based on the acoustic impedance of a single hole and fraction of perforated open area. Later, the prediction method has been used by others to estimate the acoustic impedance of a perforated panel with backed air cavity or porous materials under normal and random incidence conditions [28-31]. Takahashi believes that the effect of the diffraction phenomenon caused by impedance discontinuities of the boundary surface consists of holes, and other facing parts should be considered [32]. The new theoretically model has been formulated by Takahashi to predicts the sound absorption of the system by using wave scattering theory, and the results show fairly good agreement with the experimental data. Later, Takashi *et al.*[33] continue to developed a method that allows treatments for permeability and non-permeability plates and also identified the effect of plates backed by air cavity vibration actually depends on the plate thickness.

Atalla and Sgard later proposed a new method in prediction the acoustic response of the perforated panel [34]. According to their works, the Johnson–Allard approach for rigid screen porous with equivalent tortuosity able to model the perforated panel or screen as an equivalent fluid. This simple method can be used to predict the acoustic response for perforated panel or screen with any size of perforations ranging from 0.1mm to 1 cm with an air cavity or porous material by carefully selecting the parameters.

Recently, Kim and Yoon [35] also construct a finite element simulation method according to the Johnson–Allard model. In their work, they identified that the Johnson–Allard model with some modification on the effective density able to obtain the surface impedance model of a perforated panel similar to the Branek-Ingard model. The works show that the modification of end correction length from a modified effective density model could give a matched result on the finite element simulation.

In the latest work related with development of perforated panel concepts, parallel arrange perforated panel absorbers (PPAs) with various apertures size ranging from 1.5mm to 4mm to enhance the low frequency absorption in restricted space have been proposed by Li *et al.* [36] as illustrated in Fig. 7.

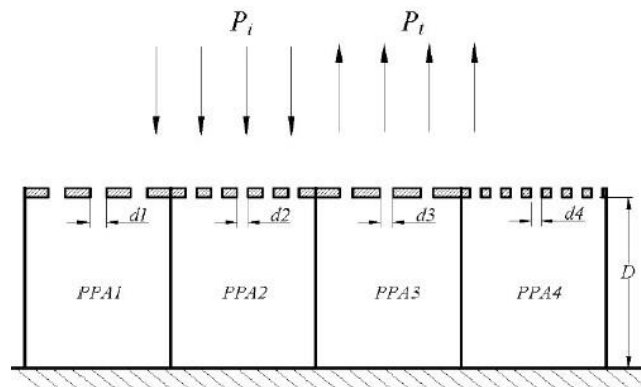

Fig. 7 - Schematic of the four parallel-arranged perforated panel absorbers [36]

In the research, the sound absorption of PPAs has been compared with parallel-arranged extended tubes (PPET) and MPP. From the comparison, the PPAs show to have better absorption than MPP at certain low-frequency ranges. The absorption bandwidth of PPAs also wider compared with MPP in the same frequency range. Meanwhile, for the comparison between PPAs and PPET, each result shows similar absorption performance in the frequency ranges between 120-150Hz. However, according to the authors, PPAs more beneficial in term of the production where PPAs have smaller depth diameter ratio and also only need low perforation rate to obtain the similar result, which simpler to be produced compared with PPET.

The research also shows that the PPAs were able to extend the absorption bandwidth up to 140Hz at low frequency in constrained space without the need to modify the depth of the cavity. Therefore, it shows that the PPAs offer simpler and easier production with better sound absorption bandwidth than MPP.

3.3 Micro-Perforated Panel Absorber

Maa [37-39] proposed a new generation absorber by reducing the perforation size into a submillimetric scale known as Micro-perforated panel (MPP). An MPP made out of a thin panel with relatively small holes ranging from 0.1mm to 1.0mm, distributed with perforation ratio between 0.5 to 1%, backed by an air cavity and rigid wall. Maa stated that the submillimetre size of perforations has sufficient acoustic resistance and low acoustic mass reactance that widen the band of the absorption without porous materials. An MPP can be made by various types of materials, including wood, metal, aluminium, and plastic. The MPP becomes a promising alternative solution and widely known as the next generation sound-absorbing material due to its fibreless nature, light in weight, durable, and also aesthetically pleasing.

According to Maa formula, the acoustic impedance of an MPP, $z = r + j\omega m$ is given by following equations [38],

$$r = \frac{32\eta t}{\sigma\rho_0 c_0 d^2} \left(\sqrt{1 + \frac{k^2}{32}} + \frac{\sqrt{2}}{32} k \frac{d}{t} \right), \quad (4)$$

$$\omega m = \frac{\omega t}{\sigma c} \left(1 + \frac{1}{\sqrt{1 + \frac{k^2}{2}}} + 0.85 \frac{d}{t} \right), \quad (5)$$

Where,

$$k = d \sqrt{\omega \rho_0 / 4\eta} \quad (6)$$

d = Holes diameter

t = Panel thickness

σ = Perforation ratio

ρ_0 = Air density

c_0 = The sound speeds

ω = Angular frequency ($\omega = 2\pi f$)

r is MPP acoustic resistance and ωm is acoustic reactance. The absorption coefficient for normal incidence describes by the following equation [45];

$$\alpha = \frac{4r}{(1+r)^2 + (\omega m - c_0 \alpha \left(\frac{D}{c_0}\right))^2}, \quad (7)$$

However, since MPP depends on its Helmholtz type resonance absorption, its capability in absorbing sound is still not enough, and its absorption limited to the middle frequency range unless it has been appropriately designed.

Many researchers come out with a variety of ideas to study the potential of MPP as a new generation type of absorber. Up to the present, lots of studies have been carried out to improve the performance of conventional MPP. The combination structure of MPP often been studied to widen the absorption frequency of MPP rather than MPP with a very small perforation. This is because MPP with small perforation is really difficult to fabricate and very costly especially for larger area.

Several MPP combination structure were proposed in order to improve the conventional MPP absorption bandwidth. Maa's in the early study has proposed double leaf of MPP backed by a rigid wall. Two leaf of MPP arranged in parallel was found has ability to create two resonance peaks which produce wider frequency range [37]. Double-leaf of MPP with air cavity in between with no rigid backing named as Double-leaf MPP space absorber (DLMPP) has been studied theoretically by Sakagami *et al.* [40]. From numerical prediction results, it shows that the DLMPP structure have similar absorption peak to the conventional MPP. However, the DLMPP structure has better absorption at low frequency compared with conventional MPP with rigid backing and the result also show that DLMPP have similar absorption to the double leaf permeable membrane at low frequency.

Next, Sakagami *et al.* [41] continue to investigate multi-leaf sound absorber with MPP by doing a research that determined the effect of honeycomb in the air space. Fig. 8 (a-b) shows the schematic and experimental specimen of DLMPP with a honeycomb in the cavity. From the study, it is identified that the absorption peak of DLMPP with honeycomb in the air cavity is increases and moves toward low frequency range in compared to result of DLMPP without honeycomb. The honeycomb structure also widens the optimal range of MPP parameter.

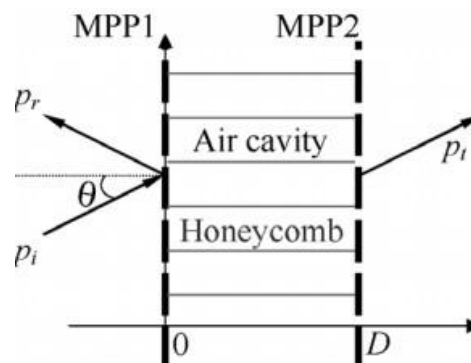

Fig. 8 - a) Schematic diagram of a DLMPP with a honeycomb [41]

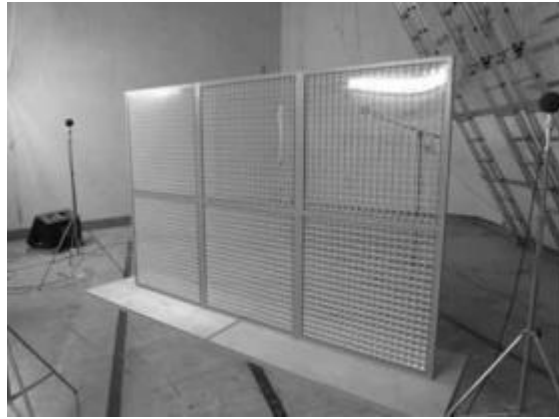

Fig. 8 - b) Experimental specimen of a DLMPP with a honeycomb [41]

Permeable membranes also have been substituting in multiple-leaf of MPP to reduce the production cost of multiple layers of MPP. The combination of permeable membrane and MPP shows better absorption characteristics than DLMPP. The studies show that the permeable membranes able to improve the sound absorption performance of MPP efficiently [41].

In order to improve MPP sound absorption, MPP structure was also not limited to uniform cavity depth only. Several studies have been conducted to broaden the MPP sound absorption bandwidth by altering the cavity depth or shape. Wang *et al.* [42] in their research arranged MPP in parallel with an irregularly shaped cavity, and it has been found that the irregular-shaped backing cavity able to made some changes on the sound absorption mechanism and frequency distribution of overall sound absorption coefficient. More resonance peak produced by MPP with irregular shape cavity noticed compared to the MPP with constant air cavity due to the changes of mode shape in the MPP. Few researchers also investigate the sound absorption of MPP with partitioned air cavity. Liu and Herrin [43] investigated the performance of partitioned backed by MPP. From the study, it shows that the partition of the air cavity has better sound absorption performance due to the disturbance of the propagation wave in the air cavity. Partially partitioned air cavity of MPP also investigated, and it has been found that partially partitioned air cavity also able to enhance the sound absorption performance of MPP especially at lower frequency.

4. Effect of Different Materials on Membrane and Panel Sound Absorption Performances

In general, membrane and panel absorbers are usually made from a thin sheet of non-porous material such as wood, metal plate, plastic and also flexible material. Since the membrane is lightweight, durable and less expensive, it's suitable for numerous applications. As absorptive materials, most of the membrane or panel material effect on the sound absorption performance is governed by the material properties such as mass density, thickness, and permeability. A series of different permeable membrane material types have been studied extensively and it has been found that the effect of membrane or panel materials relies on its material properties. However, membrane or panel material alone has insufficient sound absorption. Therefore, frequent two or more material are combined or comprised to increase sound absorption performance.

The membrane or panel absorbers were combined with a porous material to study the effects of different material on its sound absorption performance. Combination of the membrane with porous material has been found to produce better absorption. In a typical structure, the porous layer was placed behind a perforated panel to add more resistance to produced higher sound absorption since the perforated panel with larger perforation has low acoustic resistance.

Thomas and Hurst [45] conducted a research that combines panel and porous blanket. A stretched circular membrane placed in front of a porous blanket made by conventional fiberglass to study the absorption performance of membrane-blanket combination. According to the author, the combination of membrane-blanket made with less dense membrane could give good absorption in a frequency range which excluding the antiresonance frequency of the membrane.

Lee and Chen [46] also composed a porous inlaid with various perforated plates shape. On the research, the fiberglass inlaid with four types of basic inner structure compartment which are triangle, semicircle, convex rectangle and plate shape as illustrated in Fig. 9.

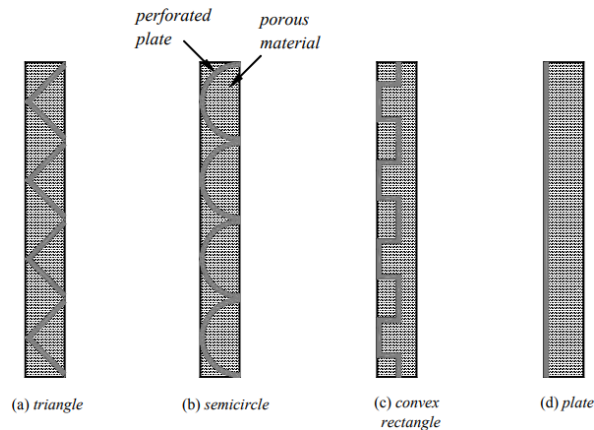

Fig. 9 - Various basic inner structure compartments of a perforated plate and porous material [46]

From the results, the porous materials improved the acoustic absorption at the low-frequency band. Additional porous materials in front of the perforated plate, especially at triangle shape compartment enhance the sound absorption at higher frequency band. This is because the porous material which is fibreglass itself already efficient in absorbing high-frequency sound. On the other hand, when the perforated plate has more porous material at the back, the absorption at lower frequency is more dominant due to the additional resistance induced from the porous material behind the perforated plate.

Sakagami [47] identified that inserting porous layers in the back cavity broaden the absorption bandwidth of the single leaf MPP due to the additional damping provided by the porous material. However, according to the authors, the effect of the porous layer mainly depends on its flow resistivity. Therefore, the appropriate value of the flow resistivity of the porous layer must be carefully selected. MPPs parameter also must be suitably adjusted to avoid excessive acoustics resistance that will affect the MPP absorption.

Li *et al.* [48] also proposed a combined absorption structure consist of MPP and porous material to widen the MPP absorption bandwidth. Porous material made by glass wool placed in seven different distances from the MPP to determine which distance or location has better absorption performance. From the research, it proves that adding the porous material can further expand the sound absorption bandwidth of the MPP. The impressive result has been discovered where a porous layer placed in front of the MPP has better sound absorption than placed in the back of the MPP. According to the authors, the absorption of the porous layer in front of MPP is much better because it became like an impedance matching layer in high frequency. The results also show that the air layer between porous materials and the MPP is needed to improve the sound-absorbing performance.

From the previous research, it can be said that the combination between two or more materials, especially porous material could provide excellent absorption performance with wider absorption bandwidth compared to a single absorber with the exact thickness. For this reason, the developments of combined materials absorber already become the main trend in the noise reduction field.

5. Finite Element Analysis of Membrane and Panel Absorber

Over the years, the development in the prediction method also become more advance. Finite Element Analysis (FEA) getting much attention due to its ability and accuracy in predicting the sound absorption performance. Finite Element Analysis (FEA) is a numerical method that can measure the response of complex structure caused by the application of forcing forces such as acoustic source or the scattering of mechanical forces. FEA also used to estimate the sound power emitted by a structure or the sound field that distributed in a confined space.

Bolton and Hou [49] working on finite element models on the micro-perforated panel, and they stated that the finite element model able to predict the performance of MPP. The authors create finite element model for the conventional metal panel, flexible thin panel and panel with different shape using Comet software and then the result was compared with the analytical model by Maa, improved Maa model, and experiment result. From the research, it is shown that the finite element model has very good prediction and performs well in dealing with complex model configuration and shape.

Wang & Huang [50] also used FEA method to stimulate the acoustic characteristics of MPP absorber array with different cavity depth under normal incidence. The finite element modelling of single MPP absorber was created using two-dimensional (2D) configurations and Three-dimensional (3D) configuration for a rigid and flexible MPP, respectively. It shows that the finite element simulation results for both types of MPP are in good agreement with the analytical solution. The MPP absorber array also has been studied experimentally to validate the finite element

simulation. The result indicated that the predictions by using finite element simulation are also in good agreement with the experiment result.

According to Qian *et al.* [51], the traditional predicting methods based on the analytic solution not suitable to predict the MPP complex configuration of MPP since this method needs a particular technique application. Therefore, numerical parametric studies on the absorption performance of MPP with tapered hole have been done based on FEA. According to the authors, the FEA method is less complicated and has a more versatile application in predicting MPP with irregularly shaped holes.

Carbajo *et al.* [52] also identified that the FEA method could be very useful in determining the absorption performance of the various perforated panel system, which includes the effect of viscous thermal. The implement of the linearized Navier Stoker formulation in the frequency domain using the FEA method able to estimate the acoustic performance under normal incident of perforated panel absorber with complex hole distribution and configuration. From the research, the numerical model has been found to have good agreement with the experimental results and able to determine the resonance frequency precisely. However, the authors suggest that the mesh must be refined in order to get an accurate prediction, and the computational resource requirement should be considered.

In a recent publication, Uenishi *et al.* [53] investigate Permeable membrane absorber array absorption characteristic using FEA. On their work, two-dimensional frequency domain FEA has been used to study the absorption characteristic of permeable absorber array with three different cavities depths compared with single-leaf absorber with rigid back cavity and honeycomb partition cavity as shown in Fig. 10. By using FEA, the contribution of each PM absorber component with different cavity depths on the overall absorption of permeable absorber array can be observed and analyzed. Yang *et al.* [54] in the latest publication also builds simulation models for standardized multilayer micro-perforated panel with finite dimension according to the finite element method. Fig.11 shows the Finite element simulation of the proposed model using software LMS Virtual Laboratory.

From the research, it shows that the simulation result obtained by the finite element method consistent with the theoretical modelling. The deviation for both results was minimized in 2.5% and 0.315% average, which indicated the accuracy of the optimal geometric parametric.

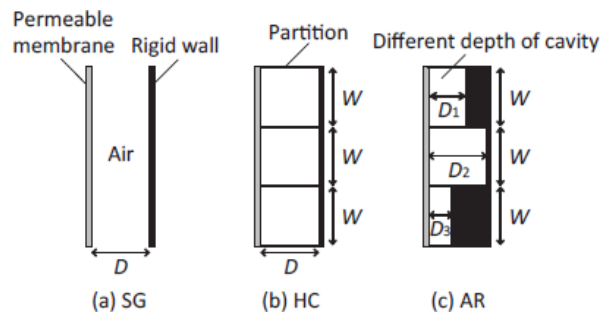

Fig. 10 - Schematic diagram of (a) Single leaf (SG), (b) Honeycomb core (HC) and (c) Array PM absorber (AR) [53]

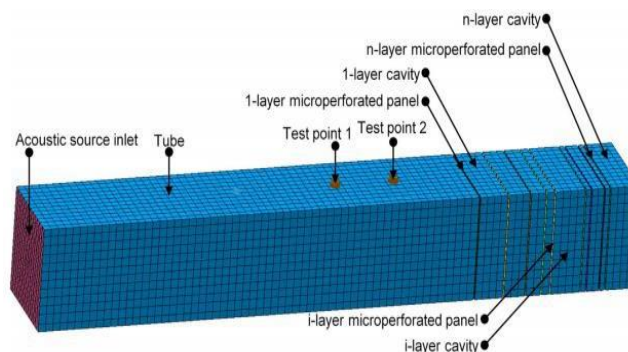

Fig. 11 - Simulation model for sound absorption performance of the multilayer micro-perforated panel [54]

Based on previous studies, it can be seen that FEA often used to predict the absorption performance of a complicated structure or configuration. This is because the FEA method is more straightforward compared to the traditional predicting methods that are based on analytical solution, such as equivalent electric-acoustic circuit method, modal analysis method and transfer matrix method.

6. Factors Influencing Acoustic Properties of Panel and Membrane Absorber

6.1 Mass Density

The mass density of a material is defined as a mass per unit area. Since the absorption of panel and membrane absorber caused by the resonance of the mass-spring system, material density is one of the important parameters to determine their acoustic properties. Sakagami *et al.* [17] identified that the effect of the mass density of the permeable membrane most significant at low frequencies. The studies show that the increases in mass density improve the absorptivity but decrease the peak frequency of absorption [15]. According to Fuchs the peak of the absorption coefficient moves toward low frequencies for membrane with higher density [11]. This finding also consistent with [13, 55, 56]. In recent studies by Sakagami *et al.* [25], the sound absorption coefficient of permeable membrane shows high absorption at low to middle frequencies for denser membrane, but at the middle to high-frequency region, it has a similar absorption with the lower density membrane.

6.2 Cavity Depth

The air cavity between rigid wall and panel or membrane absorber is essential to make the panel or membrane type absorber able to absorb the sound energy. The air backed cavity will act as acoustic spring, and then the stiffness of the air cavity will cause the panel or membrane to vibrates, thus absorb the sound energy. From the studies, the sound absorption peak shifted to the low frequency as the cavity depth increased due to the reduces of the air cavity stiffness. Sakagami *et al.* [15] observed that the sound absorption in the cavity plays a significant role in the absorption of the cavity-backed type membrane. The Membrane with no absorption in the cavity shows very poor absorption. According to the authors, the absorption of the membrane back surface able to increase the absorption of cavity backed membrane in low-mid frequency. Therefore, the high absorption of a cavity-backed membrane can be obtained by the absorption in the cavity.

Arenas *et al.* [57] investigated the sound-absorption coefficient of a circular aluminium panel using different air cavity thicknesses. The circular panel without foam was tested with three air cavity thicknesses, which are 10 mm, 20mm and 50 mm, respectively. The experiment result shows that the absorption peak value slightly decreases and also moves toward the low-frequency range as the thickness of the cavity increase. Fasold and Veres [12], in their work, stated that the air cavity thickness should be appropriately selected according to the absorbed wavelength of the sound wave.

6.3 Thickness

The thickness of the material is also known as one of the factors that influence the sound absorption performances. The sound absorption of material at low frequencies is often related to material thickness due to its wavelength size. Arenas *et al.* [57] investigate the effect of thickness on the sound absorption of circular panel absorber. In their research, two thickness of thin aluminium, 0.4 mm and 0.8 mm were tested. The result shows that there are significant increases in the resonance frequencies for a thicker plate. The study also observed that the thickness of the plate sharpens the sound absorption peak. Hamdan *et al.* [55] identified that the bandwidth of frequency is determined by the thickness of the panel or membrane. Their research shows that the thickness narrows the width of frequency ranges and shifts the absorption peak towards low-frequency ranges. The effect of thickness is insignificant at a high-frequency range. A similar finding was also observed by Gai *et al.* [58].

6.4 Perforation

Perforation on panel or membrane absorber produces a Helmholtz resonator type absorber. According to Frommhold *et al.* [59], a combination of a perforated plate and Helmholtz resonator could determine the membrane absorber behaviour. Panel with perforation found to have excellent sound absorption at low frequency and able to eliminate the needs of porous material for conventional panel absorber. The sizes of perforation usually vary from 1mm to 1 cm. However, Maa stated that a large size of perforation has insufficient acoustic resistance [38]. Maa later proposed a perforated absorber with a submillimetre size of perforation, which is less than 1mm known as Micro-Perforated Panel MPP. According to Maa, the perforated panel with submillimetre perforation able to provide sufficient acousticresistance, thus improves and broader the band of sound absorption without porous materials.

In Gai *et al.* [58] research, the effect of the perforation sizes of the perforated membrane has been studied. The result shows that the increases of perforation size move the sound absorption peaks toward the high-frequency region. This increases of perforation size also found to improves the sound absorption. However, the absorption deteriorates when the perforation becomes too large [56]. Qian *et al.* [60] investigated sound absorption characteristics of micro-perforated panel absorber with a ultra-micro perforation, which hole size less than 100 μ m. The study identified that a small perforation diameter has a broader frequency bandwidth meanwhile large perforation produces higher sound absorption coefficient. However, the sound absorption frequency bandwidth for large perforation becomes narrow due to the small acoustic resistance. The sound absorption performance of MPP with ultra-micro perforation by utilizing

micro-electromechanical system (MEMS) shows that better sound absorption performance can be attained by greatly reducing the perforation diameter.

The similar facts also observed by Cobo and Simon [61], where small perforation size has wider absorption bandwidth and shifts the absorption peaks toward high-frequency regions. It can be concluded that the perforation size controls the frequency bandwidth and the frequency range of absorption.

7. Research Gap

Membrane or panel material has been used and studied extensively as an absorptive material. The developments of membranes and panels materials are rapidly growing as well as their improvements in absorbing sound. Even though the membrane or panel has favourable characteristics as an absorber material, it is difficult to get sufficient sound absorption by a membrane or panel alone. This is because the membrane or panel mainly depends on the vibration of itself to absorb the sound energy.

Therefore, MPP has become as a new generation type of panel absorber and has been studied numerously due to its promising results in absorbing sound energy by adjusting the panel perforation ratio, perforation diameter and depth of backed cavity. Most of the MPP nowadays made from a rigid material such as stainless steel, aluminium and plastic. Due to the rigidity of the material, the panel vibration effect has been neglected in Maa classical model [38]. Several studies have been done to investigate the impact of the vibration on the acoustic impedance of MPP, and it shows that the effect of the vibration can be more significant on the lighter and thinner panel or a micro-perforated membrane (MPM) [13,61,62].

In the latest work by Marin & Arenas [63], the impervious membrane partially filled by porous materials in the backed cavity shows to have better absorption compared to the membrane with no absorbent in the backed cavity. This finding is in agreement with other previous research, where the porous layer placed in the backed cavity panel improved the absorption of the membrane, panel or MPP. Although there have been several types of research on membrane backed with porous materials, MPM with porous layer have not been explored much. The vibration of membrane on MPM could have significant influences on the acoustic impedance of perforation, which has been ignored in the MPP.

The downside with the porous material combination is it will consume much space, expensive in term of the absorber production due to its thickness and bulkiness and also some health issue. Generally, this idea is in opposition with the purpose of the MPP, which were initially developed to substitute the porous material. However, lots of new type of porous material has been developed nowadays, which is potentially able to overcome the deficiency of a porous material. Hence this combination is worth considering.

8. Summary

From the previous research, findings related to membrane or panel absorber are summarized below:

1. The sound absorption of the panel or membrane is a mass-spring resonance system which is dissipating the energy through the vibration of itself after being hit by the sound wave. Meanwhile, the perforated and micro-perforation panel absorbed sound through the vibration of the sound wave around the perforated hole area.
2. Membrane or panel absorber has better absorption at low-frequency range. The existence of perforation on the membrane or panel material improves the absorption at medium frequency range.
3. Combination of the membrane of panel absorber with other types of an absorber, especially porous material, provides excellent absorption performance with wider absorption bandwidth compared to a single absorber with the exact thickness.
4. FEA able to predict the absorption performance of a complicated structure or configuration efficiently. FEA method more straightforward compared to a traditional predicting method that is based on analytical solution, such as equivalent electric-acoustic circuit method, modal analysis method and transfer matrix method.
5. The membrane or panel material performance is governed by the material properties such as mass density, thickness, depth of air cavity and perforation. Based on the review, it has been found that:
 - a. The effect of the mass density of the permeable membrane is most significant at low frequencies. Material with high mass density improves the absorptivity and moves the absorption peak toward the low-frequency range.
 - b. The sound absorption peak shifted to the low frequency as the cavity depth increased due to the reduction of the air cavity stiffness. By adjusting the air cavity depth, the absorption resonance frequency of membrane or panel can be controlled into our desire frequency ranges.
 - c. The bandwidth of frequency is determined by the thickness of the panel or membrane. The research shows that the width of the frequency range becomes narrower, and the absorption peaks shifted towards low-frequency ranges. The effect of thickness is insignificant at a high-frequency range.
 - d. The perforation size controls the frequency bandwidth and the frequency range of absorption of membrane or panel. Membrane or panel with small perforation diameter has a broader frequency bandwidth. Meanwhile, the

large perforation sizes give a higher sound absorption coefficient. The increases of perforation size found to improves the sound absorption. However, the absorption deteriorates when the perforation becomes too large.

7. Conclusion

Based on the review, it can be concluded that the panel and membrane type of absorbers has a huge potential as a sound-absorbing material due to its impressive absorption characteristics. The investigations on the performances of the membrane and panel absorbers are still ongoing because there are still have lots of structures, materials and parameters that not be varied yet. Factors that are influencing the sound absorption of panel or membrane absorber also presented in this paper. Several parameters such as density, air cavity, thickness and perforation are found to have a contribution to the material absorption performance. It can be summarized that the sound absorption coefficient of the material depends on its parameter, and the absorption performance of the material can be maximized with appropriate parameter adjustment.

Due to the intensive development of panel and membrane absorber, it is believed that the panel and membrane absorber able to become a promising fibreless sound absorber that provides better absorption and promotes a healthy and safe environment.

Acknowledgement

The work described in this paper was fully supported by Fundamental Research Grant Scheme (FRGS), Phase 1/2015, Vot. 1549 from the Ministry of Higher Education of Malaysia.

References

- [1] Putra, A., Abdullah, Y., Efendy, H., Farid, W & Ayob, M.R. (2013). Investigation on sound absorption coefficient of natural paddy fiber. *International Journal of Renewable Energy Resources*, 3, 8-11
- [2] Nor, M.J.M., Jamaludin, N. & Tamiri, F.M. (2004). A preliminary study of sound absorption using multi-layer coconut coir fiber. *Electronic Journal Technical Acoustic*, 3, 1-8
- [3] Mahzan, S., Ahmad Zaidi, A.M., Arsat, N., Hatta, M.N. M., Ghazali, M.I., & Rasool Mohideen, S. (2010). Study on sound absorption properties of coconut coir fibre reinforced composite with added recycled rubber. *International Journal of Integrated Engineering*, 2, 29-34
- [4] Nordin, M.N.A.A., Wan, L.M., Zainulabidin, M.H., Kassim, A.S.M., & Aripin, A.M.(2016). Research finding in natural fibers sound absorbing material. *ARPN J. Eng. Appl. Sci.*,11, 8579–8584
- [5] Wan, L.M., Nordin, M.N.A.A., Zainulabidin, M.H., Kassim, A.S.M., & Aripin, A.M. (2016). Framework study of acoustical characteristics of reinforced natural fibre. *ARPN J. Eng. Appl. Sci.*,11, 8573–8578
- [6] Hashimoto, N. (1996). Experimental study on sound insulation of membranes with small weights for application to membrane structures. *Applied Acoustics*, 48, 71–84
- [7] Oldfield, R. Improved membrane absorbers. (2006). PhD dissertation. University of Salford
- [8] Schwartz, M. & Buehner, W.L. (1963). Effects of light coatings on impedance and absorption of open-celled foams. *J. Acoust. Soc. Am.*, 35, 1507–1510
- [9] Bolton, J.S. (1987). Optimal use of noise control foam. *J. Acoust. Soc. Am.*, 82, S10–S10
- [10] Ford, R.D., & McCormick M.A. (1969). Panel sound absorbers. *J. Sound Vib.*, 10(3), 411–423
- [11] Fuchs H. (2013). *Applied acoustics: concepts, absorbers, and silencers for acoustical comfort and noise control*. Berlin : Springer
- [12] Fasold, W. & Veres, E. (2003). *Schallschutz + Raumakustik in der Praxis*. Verlag für Bauwesen, Berlin,
- [13] Kang, J., & Fuchs, H.V. (1999). Predicting the absorption of open weave textiles and microperforated membranes backed by an airspace. *Journal of Sound and Vibration*, 220 (5), 905–920
- [14] Sakagami, K., Takahashi, D., Gen, H. & Morimoto, M. (1993). Acoustic properties of an infinite elastic plate with a back cavity. *Acustica*, 78, 288-295
- [15] Sakagami, K., Kiyama, M., Morimoto, M., & Takahashi, D. (1996). Sound absorption of a cavity-backed membrane: a step towards design method for membrane-type absorbers. *Applied Acoustics*, 49, 237–249
- [16] Takahashi, D., Sakagami, K., & Morimoto, M. (1996). Acoustic properties of permeable membranes. *Journal of the Acoustical Society of America*, 99, 3003–3009
- [17] Sakagami, K., Kiyama, M., Morimoto, M. & Takahashi, D. (1998). Detailed analysis of the acoustic properties of a permeable membrane. *Applied Acoustic*, 54, 93–111
- [18] Kiyama, M., Sakagami, K., Tanigawa, M., & Morimoto, M. (1998). A basic study on acoustic properties of double-leaf membranes. In *Applied Acoustics*, 54(3), p. 239-254
- [19] Sakagami, K., Kiyama, M., Uyama, T. & Morimoto, M. (1998). Absorption characteristics of a double-leaf membrane with an absorptive layer in its cavity. In *Proceedings 16th International Congress on Acoustics and 135th Meeting of the Acoustical Society of America*, 2735–2736
- [20] Sakagami, K., Morimoto, M. & Kiyama, M. (2000). Acoustic properties of a triple-leaf membrane. *J. Acoust. Soc. Am.*, 108(5), 2513

- [21] Sakagami, K., Nakamori, T., Morimoto, M. & Yairi, M. (2011). Absorption characteristics of a space absorber using a microperforated panel and permeable membrane. *Acoust. Sci. Technol.*, 32, 47–49
- [22] Sakagami, K., Fukutani, Y., Yairi, M., & Morimoto, M. (2014). Sound absorption characteristics of a double-leaf structure with an MPP and a permeable membrane. In *Applied Acoustics*, 76, 28-34,
- [23] Sakagami K, & Morimoto, M. (2007). Sound absorption characteristics of panel absorber with an air cavity of non-uniform depth. *Memoirs of Graduate School of Science and Technology Kobe University*, 25A, 25-31
- [24] Sakagami, K., Okuzono, T., Somatomo, Y., Funahashi, K. & Toyoda, M. (2019). A basic study on a rectangular plane space sound absorber using permeable membranes. *Sustainability*, 11(7), 2185
- [25] Sakagami, K., Funahashi, K., Somatomo, Y., Okuzono, T., Nishikawa, C. & Toyoda, M. (2015). An experimental study on the absorption characteristics of a three-dimensional permeable membrane space sound absorber. *Noise Control Engineering Journal*, 63(3), 300–307
- [26] Toyoda, M., Funahashi, K., Okuzono, T. & Sakagami, K. (2019). Predicted Absorption Performance of Cylindrical and Rectangular Permeable Membrane Space Sound Absorbers Using the Three-Dimensional Boundary Element Method. *Sustainability*, MDPI, Open Access Journal, vol. 11(9), 1-15
- [27] Bolt, R.H. (1947). On the design of perforated facings for acoustic materials. *J. Acoust. Soc. Am.*, 19, 917–921.
- [28] Ingard, U., and Bolt, R.H. (1951). Absorption characteristics of acoustic material with perforated facings. *J. Acoust. Soc. Am.*, 23, 533–540
- [29] Ingard, U. (1953). On the theory and design of acoustic resonators. *J. Acoust. Soc. Am.*, 25(6), 1037–1061.
- [30] Ingard, U. (1994). *Notes on sound absorption technology*. New York: Noise Control Foundation
- [31] Allard, J.F. (1993). *Propagation of sound in porous media*. Elsevier Applied Science,
- [32] Takahashi, D. A new method for predicting the sound absorption of perforated absorber systems. *Applied Acoustic*, 51(1), (1997), 71–84
- [33] Takahashi, D., & Tanaka, M. Flexural vibration of perforated plates and porous elastic materials under acoustic loading. *The Journal of the Acoustical Society of America*, 112(4), (2002), 1456–1464
- [34] Atalla, N., & Sgard, F. (2007). Modelling of perforated plates and screens using rigid frame porous models. *J. Sound Vib.*, 303, 195–208
- [35] Kim, K. H., & Yoon, G.H. (2017), Absorption performance optimization of perforated plate using multiple-sized holes and a porous separating partition. *Applied Acoustics*, 120, 21–33
- [36] Li X, Wu Q, Kang L, & Liu B. (2019). Design of Multiple Parallel-Arranged Perforated Panel Absorbers for Low Frequency Sound Absorption. *Materials*. 12(13), 2099
- [37] Maa, D.Y. (1987). Microperforated-Panel wideband absorber. *Noise Control Engineering Journal*, 29, 77-84.
- [38] Maa, D.Y. (1998). Potential of Microperforated Panel Absorber. *Journal of the Acoustical Society of America*, 104, 2861-2866
- [39] Maa, D.Y. (2007). Practical Single MPP Absorber. *International Journal of Acoustic and Vibration*, 12, 3-6.
- [40] Sakagami K, Morimoto M, & Wakana K. (2005). A numerical study of double-leaf microperforated panel absorbers. *Appl Acoust*, 67, 609–19
- [41] Sakagami K, Yairi M, & Morimoto M. (2010). Multiple-leaf sound absorbers with microperforated panels: an overview. *Acoust Aust* 38, 64–9
- [42] Wang, C., Cheng, L., Pan, J., and Yu, G. Sound absorption of a micro-perforated panel backed by an irregular-shaped cavity. *J Acoust Soc Am* 2010;127:238–46
- [43] Liu, J., & Herrin, D. (2010). Enhancing micro-perforated panel attenuation by partitioning the adjoining cavity. *Applied Acoustics*, 71(2), 120-127
- [44] Huang, S., Li, S., Wang, X., & Mao, D. (2017). Micro-perforated absorbers with incompletely partitioned cavities. *Applied Acoustics*, 126, 114-119
- [45] Thomas, W.A. & Hurst, C.J. (1976). Acoustic Performance of a Stretched Membrane and Porous Blanket Combination, *Journal of the Acoustical Society of America*, 59(5), 1071-1076
- [46] Lee, F.C., and Chen, W.H. (2003). On the acoustic absorption of multi-layer absorbers with different inner structures. *Journal of Sound and Vibration*, 259, 761–777
- [47] Sakagami, K. (2015). Sound absorption systems with the combination of a microperforated panel (MPP), permeable membrane and porous material: Some ideas to improve the acoustic performance of MPP sound absorbers. *International Journal of Research and Reviews in Applied Sciences*, 24(2), 59
- [48] Li D, Chang D, Liu B, & Tian J. (2014). Improving sound absorption bandwidth of microperforated panel by adding porous materials. *Inter-noise*, 1, 1–6
- [49] Bolton, J.S., & Hou, K. (2009). Finite element models of micro-perforated panels. *INTER-NOISE and NOISE-CON Congress and Conference Proceedings*, InterNoise09, 2420–2428
- [50] Wang, C., & Huang, L. (2011). On the acoustic properties of parallel arrangement of multiple micro-perforated panel absorbers with different cavity depths, *Journal of the Acoustical Society of America*, 130 (1), 208–218
- [51] Qian, Y.J., Cui, K., Liu, S.M., Li, Z.B., Kong, Y., and Sun, S.M. Numerical study of the acoustic properties of micro-perforated panels with tapered hole. *Noise Control Eng. J.* 62 (3), 2014, 152–9
- [52] Carbajo J, Ramis J, Godinho L, Amado-Mendes P, & Alba, J. (2015). A finite element model of perforated panel

- absorbers including viscothermal effects. *Appl Acoust*, 90,1–8
- [53] Uenishi, K., Okuzono, T., & Sakagami, K. (2017). Finite element analysis of absorption characteristics of permeable membrane absorbers array, *Acoustical Science and Technology*, 38, 322–325
- [54] Yang, X.C., Bai, P.F., Shen, X.M., To, S., Chen, L., Zhang, X.N., & Yin, Q. (2019). Optimal design and experimental validation of sound absorbing multilayer microperforated panel with constraint conditions, *Appl. Acoust.* 146, 334–344
- [55] Hamdan, N.I, Zainulabidin, M.H., Kasron, M.Z., Ismail, A.E, & Kassim, A.S. (2018).Effect of Perforation Size on Sound Absorption Characteristics of Membrane Absorber. *International Journal of Integrated Engineering*, 10(4), 27-34
- [56] Song, J. & Bolton, J.S. (2003). Sound absorption characteristics of membrane based Sound absorbers, *INTERNOISE 2003 Conference Proceedings*, Korea
- [57] Arenas, J.P.,& Ugarte,F. (2016). A note on a circular panel sound absorber with an elastic boundary condition. *Applied Acoustic*, 114, 10-17
- [58] Gai, X.-L., Li, X.-H., Zhang, B., Xie, P., & Ma, Z.H. (2013). Modelling of Perforated Screens or Membrane using Rigid Frame Porous Models Combined with Thin Membrane Resonance Sound Absorbing Theory. *Applied Mechanics and Materials*, 357-360, 1206-1211
- [59] Frommhold, W., Fuchs, H.V., & Sheng, S. (1994). Acoustic performance of membrane absorbers. *J Sound Vib.*, 170, 621–636
- [60] Qian, Y.J., Kong, D.Y., & Fei, J.T. (2015). A note on the fabrication methods of flexible ultra-micro-perforated panels. *Applied Acoustic*, 90,138–142
- [61] Toyoda, M., Mu, R. L., & Takahashi, D. (2010). Relationship between Helmholtz-resonance absorption and panel-type absorption in finite flexible microperforated-panel absorbers,*Applied Acoustics*, 71, 315-320
- [62] Bravo, T., Maury, C., & Pinhede, C. (2012). Vibroacoustic properties of thin micro-perforated panel absorbers,” *Journal of the Acoustical Society of America*, 132, 789-798
- [63] Marín, V.. & Arenas, J.P. (2019). Sound absorption provided by an impervious membrane / cavity / activated carbon arrangement. *Proceeding of the 23rd int.congress on acoustic*. 2967-2973