



Development of Pesticide Sprayer Robot Prototype for Chilli Farm Agricultural Application

Sumaiya Mashori^{1*}, Muhammad Amar Aizad Azmi², Norain Sahari¹, Nor Anija Jalaludin¹, Sim Sy Yi³, Rasida Norjali¹, Mohamad Helmee Mohd Yusof⁴

¹Faculty of Engineering Technology,
University Tun Hussein Onn Malaysia (UTHM) Pagoh Campus, KM1, Jalan Panchor, Muar, Johor, 84600,
MALAYSIA

²Panasonic Appliances Air-Conditioning Malaysia Sdn. Bhd.,
Lot 2, Persiaran Tengku Ampuan, Section 21, Shah Alam Industrial Site, Shah Alam, Selangor, 40300, MALAYSIA

³Faculty of Electrical and Electronic Engineering,
University Tun Hussein Onn Malaysia (UTHM), Parit Raja, Johor, 86400, MALAYSIA

⁴Pertubuhan Peladang Kawasan Simpang Renggam,
No. 14, Jalan Sinar, Taman Sinar, Simpang Renggam, Johor, 86200, MALAYSIA

*Corresponding Author

DOI: <https://doi.org/10.30880/ijie.2023.15.03.023>

Received 21 June 2023; Accepted 17 July 2023; Available online 2 October 2023

Abstract: Accidental spills of chemicals, leakages, poor spraying equipment, or a lack of knowledge about personal protection equipment usage can expose farm workers to pesticides either in open fields or greenhouse. Pesticides may affect their health, particularly on dermal contact and respiratory system. Besides that, traditional pest management for massive agriculture industry requires a big number of employees, large quantities of pesticides, and the risk of inefficient and uneven pesticides coating. Therefore, a pesticide spraying robot, which is equipped with two ultrasonic sensors is developed to spray pesticide independently and allows the workers to maximize pesticide usage on the agricultural application such as chilli farm. The prototype is designed to automatically moves and operate in two modes, either automatic or manual. For automatic mode, the robot travel and operated independently without human control or intervention. While for manual mode, the Blynk application is used to remotely control the robot's movement and spraying insecticide. In this research, the garlic extract and dishwashing liquid detergent were used as organic insecticides since they are effective and safe for plants and the environment. The study discovered that for a 50 cm two-month chilli plant, a three-seconds pesticide setting was appropriate, with 30 ml pesticide applied per chilli plant.

Keywords: Agricultural Robot, Pesticide Sprayer, Autonomous, Organic Insecticide, Garlic Extract

1. Introduction

Thrips (Thysanoptera), aphids (Hemiptera: Aphididae) and silverleaf whitefly (Bemisia Tabaci) are agricultural pests that attack chilli plants (*Capsicum annum* Linnaeus). Thrips attack immature leaves or the upper leaves of the chilli plant, which are identified by a silvery-white leaf, causing distortion on the leaves, which later turn to brownish colour and fall off [1]. Leaf damage, chlorosis, stunting, cell death, distortion of new development, poorer agricultural

output, and curled leaves with reduced leaf size are all symptoms of aphid infection [2]. Silverleaf whiteflies recognize white to yellow bodies with white wings that tilt up and hang over the bodies found on the underside of the leaves. It can harm immature chilli plants, causing nutrition loss, preventing them from maturing, and reducing plant growth, leaf loss and poor harvest [3].

The pesticide must be used to improve the quality and longevity of all chilli plants to reduce pests' frequency. Traditional pest management (hand-spraying pesticides) is often done using sprayers carried on someone's back and walked from crop to crop (manual) or, if possible, with a compact tractor-based system equipped with air blast sprayers. However, both existing options have a weakness. Tractors have a low spraying efficiency due to narrow row size and soil structure concerns, and hand spraying is difficult due to a lack of farm workers willing to perform a heavy, non-ergonomic task.

Manual sprayer also requires a lot of personnel and results in an inefficient and inconsistent pesticide coating, requiring the use of more pesticides. On the other hand, some researchers discovered that direct exposure to pesticides and a lack of knowledge about personal protective equipment usage (coveralls, protective boots, glasses/goggles, gloves, respirator and hat) when handling pesticides in open fields or greenhouse could cause symptoms such as headaches, skin irritation, nausea, itchy eyes, dizziness, fatigue, coughing, poor vision, stomach ache, excessive sweating, shortness of breath, vomiting and increased risk of acute and chronic health effects include cancers [4,5,6]. Researchers claimed that the farm workers who spray with small hoses are more likely to develop occupational pesticide behaviors and lung cancer than those who spray with large hoses [5].

2. Previous Research on Smart Pesticide Sprayer System Technology

Smart pesticide sprayer system technology is being developed to replace manual spraying operations, increase production, optimize pesticide usage, and improve the working efficiency of agricultural spraying operations without requiring a significant number of people [7,8]. The robot can freely move around the crop field, recognizing the targeted plant and controlling the spraying mechanism. Certain researchers built a system with an ultrasonic sensor, and a microcontroller controlling the actuation. An autonomous pesticide sprayer robot is tested inside a chilli fertigation farm with about 100 chilli plants. In this paper, the author shows that a robot could self-navigate by applying the obstacles avoidance idea and turning at the junction as its next route [9]. An automated rover pesticide sprayer that used an ultrasonic sensor for navigation was able to detect and spray either the left or right side of the chilli plant, or both sides. When utilizing an organic pesticide mixture of wood vinegar, the recommended time for a pesticide sprayer is 5 to 7 seconds per chilli plant [10].

Wi-Fi modules, a camera, a mobile phone and a smart monitoring system were used to develop an intelligent robot. The developed system utilizes a video capture module for live robot navigation, which includes observing the surrounding environment, tracking objects, and transmitting video data to the phone through Wi-Fi. The result demonstrates that the robot can adapt to various road conditions, including concrete, mud, gravel, grass driving, and 30-degree slope. The spray test result shows a fine mist spray nozzle dropping uniformly on crop moisture [11]. The images captured by the camera are analyzed using a machine learning-based vision system, and each disease is categorized in the database. The robot also has a float sensor that detects whether the amount of pesticide in the spraying bottle is above or below the threshold [12]. Other researchers used solar energy to power the robot and Blynk apps to manage it. The robot can adjust the sprayer height according to the plant height by using Hydraulic mechanism [13].

Traditional farmers or organic farmers can manage agricultural pests with a variety of homemade organic insecticides that are less expensive, natural, organic, less toxic than synthetic pesticides that contain hazardous chemicals, safer for plants, and environmental-friendly for the ecological system and the health of all life forms [14,15]. Garlic and neem extracts solution have insecticidal properties that can be used to control lepidoptera, hemiptera, insects, mites, and fruit flies, while a garlic and red chilli extract combination can control red spider mite in tomato production [16, 17]. In cabbage farms, the garlic and chilli combination solution reduce pests, improves plant development, and improves quality [18]. Applying wood vinegar solution can help to improve photosynthesis, nutritional absorption, and plant growth and reduce whitefly attacks [19].

This study presented the developed Agricultural Pesticide Spraying Robot (APSR) with two ultrasonic sensors that can independently control the robot's movement and spray pesticide on a 50 cm two-month chilli farm. Furthermore, the effectiveness of a prototype that can operate in two modes (autonomous and remote manually), travel freely without human involvement in autonomous mode and be easily navigated and controlled in remote manual mode is examined. The Blynk application is used to control the robot's movement as well as spray insecticide from afar. The garlic extract and dishwashing liquid detergent were employed as pesticides in the test since they are natural, organic products that are effective and safe for plants and the environment. The most important aspect is that the knowledge gained from this study enables workers to reduce manpower requirements, maximize pesticide usage on the chilli farm, switch to organic pesticides instead of chemical pesticides, and implement a pesticide sprayer robot to protect farm workers from pesticide exposure, all of which result in improved health and well-being.

3. Hardware Configuration

3.1 APSR Prototype Construction

Fig. 1 illustrates the length, width, and height measurements of the APSR prototype, which are 35, 24 and 65 cm, respectively. The height of APSR prototype has been decided to be 65 cm, which is appropriate for chilli plants that have reached the age of two months and a height of 50 cm, while the width has been determined to be 24 cm due to the chilli farm’s row size is approximate to 100 cm. Table 1 shows the APSR prototype requirements and the design generated with Sketchup software. The navigation system and spraying system are two elements of the APSR prototype development.

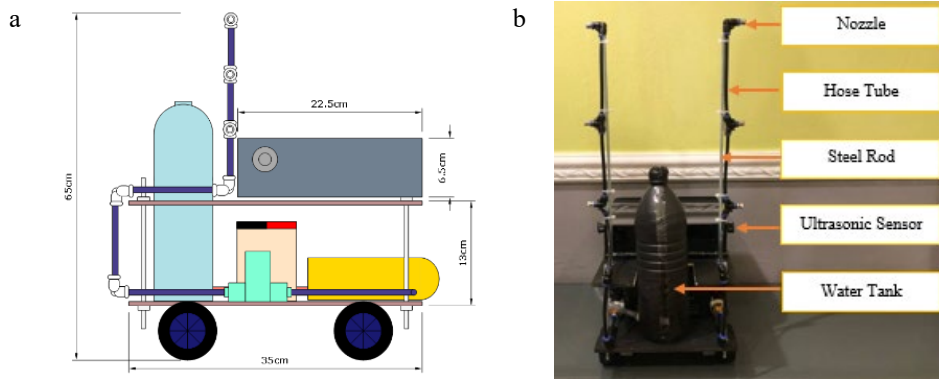

Fig. 1 - APSR prototype (a) design; (b) developed

Table 1 - APSR prototype specifications

Item	Specification
Robot dimension	35 cm x 24 cm x 65 cm (L x W x H)
Robot weight	6.1 kg without payload
Drive system	4-wheeled drive system
Power supply	12Vdc rechargeable battery and 3.7Vdc
Ground clearance	6 cm from the ground
Payload	Max: 1.5kg
Control type	Automatic and remote manual
Mobile apps	Blynk application

Fig. 2 illustrates the APSR prototype’s overall connection. The connectivity of the required components in the proposed robot is critical, and it plays a key role in ensuring that the robot operates as expected. Misconnections between the electronic components might cause the developed system to fail, preventing the project's objectives from being met.

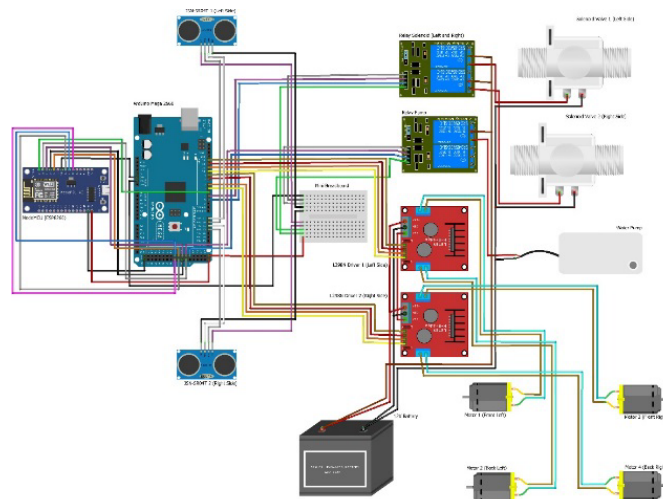

Fig. 2 - APSR prototype circuit diagram

3.2 Navigation System

The navigation system for APSR prototype consists of two waterproof ultrasonic sensors (JSN-SR04T), an Arduino Mega 2560 microcontroller, NodeMCU, four units of 12 VDC worm gear motor (200 rpm), two motor drivers (2 Amp 7V-30V L298N), and a 12 VDC 7.0 AH rechargeable battery. The microcontroller is the system's brain, where programs are developed in C++ using the Arduino IDE and then uploaded to control the prototype's sequence and operation.

The APSR prototype has two operation modes: autonomous and remote manual. The sensor is an important component in automatic mode to ensure that the robot is able to travel in the chilli farm without human involvement and the spraying system is activated when the plant is detected in range. Using the Blynk application interface on the mobile phone, farm workers may easily browse and manage the robot's movement and spray pesticides when in remote manual mode, as shown in Fig. 3.

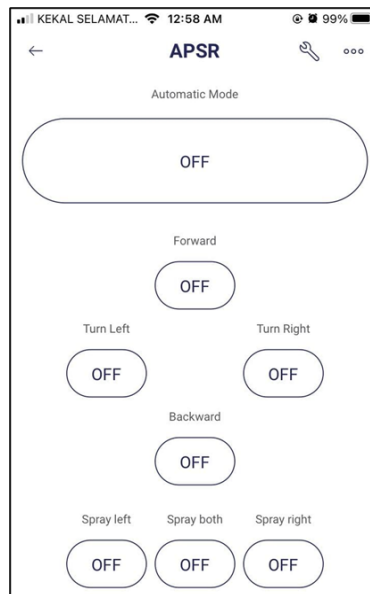

Fig. 3 - Blynk application of the APSR prototype on a mobile phone

3.3 Spraying Mechanism

A 12V/100W diaphragm water pump was chosen to carry the 1500 ml organic pesticide filled in the water tank to the spraying nozzle. Two 5V 2-channel relay boards connected the microcontroller and the water pump. The microcontroller's input signal causes the relay contact to change state from normally open (NO) to normally closed (NC), allowing the spraying mechanism to be activated. The relay board was connected to both solenoid valves 1 (which activated the left-side spraying mechanism) and 2 (which activated the right-side spraying mechanism). The water pump will be shut off and the solenoid valve will be de-energized once the spraying process is done. Each spraying mechanism on the left and right sides has three layers of nozzles that mist, allowing the pesticide to be sprayed in the three levels, allowing the spraying procedure to be done quickly and efficiently.

In automatic mode, the APSR prototype will execute both navigation and spraying activities at the same time. The robot will move in a straight path and navigate freely in the crop field once the automatic mode is started. If the ultrasonic sensor recognizes the targeted plant, the spraying mechanism will be activated on the left, right, or both sides. In the remote manual mode, the robot will behave according to the pressed button and be controlled via a Blynk application on a mobile phone, either for robot movements or an activated spraying mechanism. When the robot is first turned on, the power supply is supplied to the controller, and the robot is in remote manual mode by default. All input sensors and output functions are initialized for the first time, and the robot reacts to the specific operation, either in automatic or remote manual mode.

4. Experimental Setup

Fig. 4 illustrates the experimental setup on a chilli farm. The farm's row was set up with a minimum distance of 0.7 m between each pot and a minimum distance of 1 m between each row. The APSR prototype will start moving in one column at a time and will keep moving until the row is completed. The robot will then return to its original location under remote manual direction via mobile phone. As a result, the robots can remotely spray pesticides on plants in manual mode if required.

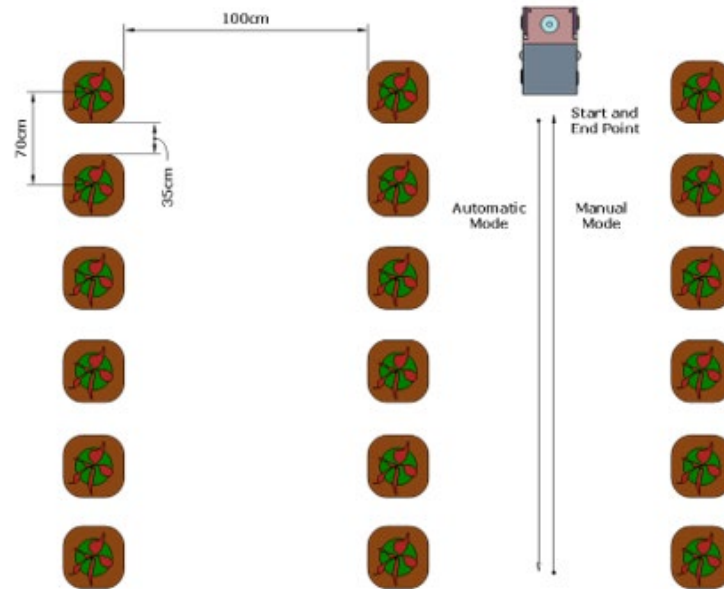

Fig. 4 - Experimental setup in chilli farm

Fig. 5 shows a chilli plant leaf with mosaic virus symptoms caused by aphids and whiteflies. Infected chilli plants have stunted, pale green or leathery leaves, specks or ring marks, and a mosaic look with dark and light spots. Aphids should be treated as soon as possible to prevent the spread of disease.



Fig. 5 - Mosaic virus symptom in chilli farm

This experiment is carried out to determine the sensor's ability to identify the existence of a chilli plant that has reached the age of two months and a height of 50 cm, as well as to activate the spraying mechanism in response. Instead of using synthetic pesticides, organic insecticide is used in this study. To make the organic pesticide from garlic extract, blended one garlic bulb with a cup of water, and let it sit for 24 hours. Strain the garlic extract and mix with 2 liters of water and one teaspoon of sunlight dishwashing liquid detergent (aloe vera). Then give a good shake before spraying. It is best to spray the insecticide early in the morning or late in the evening because the midday heat may cause the garlic extract to leaf burn.

The experimental method used in this study is based on previous research [10]. The APSR prototype, in contrast to earlier studies, has two modes of operation: autonomous and remote manual. As a result, both operational modes will be investigated for navigation and spraying mechanisms. The ability of the ultrasonic sensors on the right, left (shown in Fig. 6(a)) and both sides (shown in Fig. 6(b)) to recognize the chilli plant and activate the pesticide spraying mechanism in autonomous mode was assessed. The accuracy of spraying duration, the total amount of pesticide used for each chilli plant, and pesticide coverage on the topside and underside leaves were all tested in this study through a series of trials.

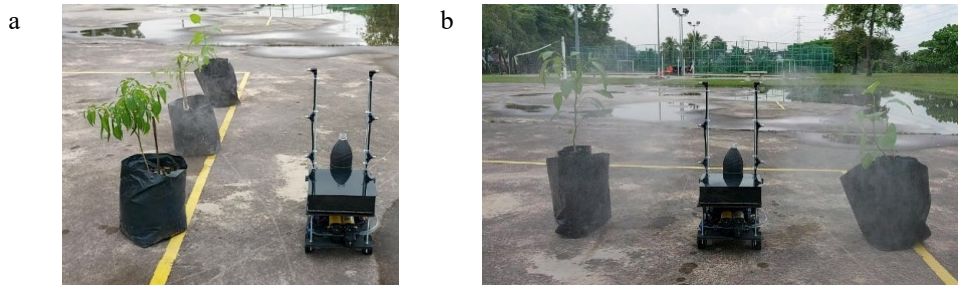

Fig. 6 - Experimental setup for autonomous mode (a) one side; (b) both sides

In remote manual mode, as shown in Fig. 7, the Blynk application interface on a mobile phone allows farm workers to easily browse and manage the robot’s movement and spraying pesticides. The robot will behave according to the pressed button and be controlled via a Blynk application on a mobile phone, either for robot movements (forward, backward, turn right, turn left) or activated spraying mechanisms (spray left, spray right, spray both).

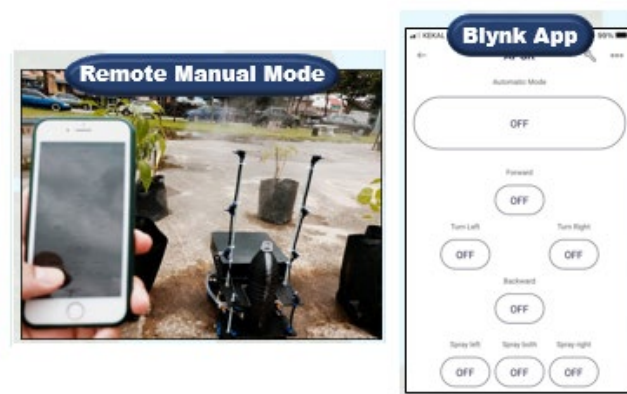

Fig. 7 - Experimental setup for remote manual mode

5. Result and Analysis Data

Fig. 6(a) shows the fundamental experimental setup for autonomous mode. Chilli plants are planted on one side of the path, separated by about one meter. When the robot is switched on, it will proceed in a straight line until it reaches the first chilli plant. Spraying time range from 1 to 5 seconds, with each time being measured three times. The robot takes three seconds to go from one chilli plant to another. Table 2 summarizes the measured and collected data during the experiment. According to the study, a three-second pesticide setting was found to be adequate for a 50 cm two-month chilli plant, with 30 ml pesticide applied per chilli plant.

Table 2 - Summary of one side pesticide sprayer for autonomous mode

Spraying time (s)	No. of Test	Amount of pesticide used (ml)	Percentage pesticide coverage (%)	Pesticide coverage quality
1	1	10	Top side = 65 Underside = 55	Low
	2	11	Top side = 67 Underside = 58	
	3	10	Top side = 65 Underside = 55	
2	1	21	Top side = 78 Underside = 70	Moderate
	2	20	Top side = 76 Underside = 69	

	3	20	Top side = 76 Underside = 69		
	1	29	Top side = 90 Underside = 88		
	3	2	30	Top side = 90 Underside = 88	Great
	3	31	Top side = 90 Underside = 88		
	1	51	Top side = 98 Underside = 96		
	5	2	50	Top side = 97 Underside = 95	Over supply
	3	51	Top side = 98 Underside = 96		

Fig. 8 shows how pesticide coverage data is captured visually on both the top and under the leaves sides. The more pesticide is sprayed on the plant, the higher the pesticide coverage percentage. Due to the time required by the pump to drive the pesticide through the sprayer nozzle, spraying times of less than two seconds were determined to be insufficient. Pesticide wastage was observable after three seconds of spraying, indicating that there was an oversupply of insecticides for one chilli plant.



Fig. 8 - Pesticide coverage quality on top side (a) 2 seconds; (b) 3 seconds of spraying time

Fig. 6 (b) shows the second experimental setup, in which the chilli plants are arranged in parallel lines one meter apart on the left and right sides. From the first experiment, the proper three-seconds spraying time is decided to be employed in the second experiment. The robot starts in the starting location and moves in a straight line until it stops between two chilli plants, where it activates the spraying mechanism on both sides. The robot will continue to travel in a straight line until it reaches the final row of chilli trees.

According to the research, the total time required for navigation and pesticide spraying for a row of twelve chilli plants as illustrated in Fig. 4, is tabulated in Table 3. When the amount of pesticide is between 1450 and 1500 mL, the APSR prototype can spray up to 50 chilli plants in autonomous mode, and the average time for the robot to spray pesticides on twelve chilli plants is 39 seconds, and only one worker is required to control the APSR prototype. As a result of the findings, employees will be able to minimize staffing requirements while maximizing pesticide usage on the chilli farm.















Table 3 - Both sides pesticide sprayer for autonomous mode

Spraying time (s)	Spraying time for two rows (s)	Average time (s)	Amount of pesticide used (ml)	Average quantity of chilli plant
3	38 - 40	39	480	50

The APSR prototype’s behaviour in the remote manual mode is determined in the third experimental setup, as shown in Fig. 7. A Blynk application on a smartphone is used to control the robot’s movement and spray insecticides. As a result, controlling the robot is simple and user-friendly. To begin, the user needs to use the forward button to instruct the robot to move straight forward until it comes across a plant. Although the robot could travel in any direction, it will move according to the given instructions. The spray button is pressed when the robot is parallel to the plant, depending on the position of the chilli plant. The (sprayleft) button is pressed for the plant on the left. While pressing the (sprayright) button for the right-side plant. The (sprayboth) button is press when the plants are on both sides.

The APSR prototype behaviour is given in Table 4 and indicates that the APSR prototype reacts differently depending on which button is pressed. This robot is designed to let farmers spray pesticides from afar without getting into physical contact with them, as well as to safeguard agricultural employees from pesticide exposure.

Table 4 - Summary of remote manual mode

Command	Control Sign	APSR behaviour
Forward	Forward 	
Backward	Backward 	
Left	Turn Left 	
Right	Turn Right 	
SprayLeft	Spray left 	
SprayRight	Spray right 	
SprayBoth	Spray both 	

6. Conclusion

Finally, this project has developed a successful APSR prototype, starting with the design and development of the navigation system and spraying mechanism. The result demonstrates that the developed APSR prototype can be operated in two modes (autonomous and remote manual), traveling freely without human involvement in autonomous mode and being readily navigated and controlled in remote manual mode. The Blynk application on a smartphone is used to remotely manage the robot's movement and activate the spraying mechanism, protecting farm workers from pesticide exposure and improving their health and well-being. The research indicates that for a 50 cm two-month chilli plant, a three-second spraying organic insecticides duration was enough in autonomous mode, with 30 ml pesticide applied per chilli plant. With a pesticide volume of 1450 to 1500 mL, the APSR prototype can spray up to 50 chilli plants, and the average time for the robot to spray pesticides on twelve chilli plants is 39 seconds and only requires one

worker to operate the APSR prototype. The findings show that this research can help workers save time and money by reducing personnel requirements, replacing traditional pesticide sprayers with a robot, and maximizing pesticide consumption on the chilli farm. Considering garlic extract and sunlight dishwashing liquid detergent are natural, organic items that are effective and safe for plants and the environment, they were used as insecticides in this study. The most important aspect is that the workers will be able to minimize manpower as a response to the information obtained from this research. For future improvement, it is recommended that the effect of garlic extract and sunlight dishwashing liquid detergent (aloe vera) combination solution on chilli growth (number of leaves per chilli plant) and insect pest resistance be observed one to five days after spraying. The spraying mechanism height might also be increased to 2 m, which is the average mature chilli plant height.

Acknowledgement

This research is supported by Universiti Tun Hussein Onn Malaysia (UTHM) through Tier 1 Grant research (Q352).

References

- [1] Johari, A., Herlinda, S., Irsan, C. & Pujiastuti, Y. (2016). Phenomenon of Thrips (Thysanoptera) attack on chilli plant (*Capsicum annuum* L.). *American Journal of Agricultural and Biological Sciences*. 11(3), 103-109. <https://doi.org/10.3844/ajabssp.2016.103.109>
- [2] Florencio-Ortiz, V., Selles-Marchart, S. & Casas, J.L. (2021). Proteome changes in pepper (*Capsicum annuum* L.) leaves induced by the green peach aphid (*Myzus persicae* Sulzer). *BMC Plant Biology*. 21:12, 1-18. <https://doi.org/10.1186/s12870-020-02749-x>
- [3] Niranjandevi Jeevanadham, Murugan Marimuthu, Senthil Natesan, Shanthi Mukkaiyah & Sathiyamurthy Appachi (2018). Levels of Plant Resistance in Chillies *Capsicum* spp against Whitefly, *Bemisia tabaci*. *International Journal of Current Microbiology and Applied Sciences*. 7(1), 1419-1441. <https://doi.org/10.20546/ijcmas.2018.701.174>
- [4] Mustapha F.A. Jallow, Dawood G. Awadh, Mohammed S. Albaho, Vimala Y. Dewi & Binson M. Thomas, (2017). Pesticide knowledge and safety practices among farm workers in Kuwait: results of a survey. *International Journal of Environmental Research and Public Health*. 14(4), 340. <https://doi.org/10.3390/ijerph14040340>
- [5] Mahyuni EL, Haharap U, Harahap RH, Nurmaini N. (2021). Pesticide toxicity prevention in farmer's community movement. *Open Access Macedonian Journal of Medical Sciences*. 9(E), 1-7. <https://doi.org/10.3889/oamjms.2021.5565>
- [6] Ratana Saphamrer, Manoch Naksata, Surat Hongsibsong, Klintean Wunnapuk, Anucha Watcharapasorn & Jiraporn Chittrakul (2021). How to protect agricultural workers from exposure to pesticides: Effectiveness of woven and natural resin-coated fabrics. *Cogent Engineering*. 8:1, 1932241. <https://doi.org/10.1080/23311916.2021.1932241>
- [7] Baltazar, A.R., Santos, F.N.d., Moreira, A.P., Valente, A. & Cunha, B.J (2021). Smarter Robotic Sprayer System for Precision Agriculture. *Electronics*. 10(17), 2061. <https://doi.org/10.3390/electronics10172061>
- [8] P. Rajesh Kanna & R. Vikram (2020). Agricultural Robot-A pesticide spraying device. *International Journal of Future Generation Communication and Networking*. 13(1), 150-160.
- [9] A.M. Kassim, M.F.N.M. Termezai, A.K.R.A. Jaya, A.H. Azahar, S. Sivarao, F.A. Jaafar & M.S.M. Aras (2020). Design and Development of Autonomous Pesticide Sprayer Robot for Fertigation Farm. *International Journal of Advanced Computer Science and Applications*. 11(2), 545-551. <https://doi.org/10.14569/IJACSA.2020.0110269>
- [10] T. M. Q. B. T. FARID (2021). Automated Rover Pesticide Spray System in Agriculture Sector. B.Sc Thesis. Universiti Tun Hussein Onn Malaysia.
- [11] Jiansheng Peng (2014). An Intelligent Robot System for Spraying Pesticides. *The Open Electrical & Electronic Engineering Journal*. 8, 435-444.
- [12] Pvr Chaitanya, Dileep Kotte, A. Smitch & K.B. Kalyan (2020). Development of Smart Pesticide Spraying Robot. *International Journal of Recent Technology and Engineering*. 8(5), 2193-2202. <https://doi.org/10.35940/ijrte.E6343.018520>
- [13] Ravi Gorapudi, Bhargava Rama Sai Pavan Rudrapaka & Aadi Seshu Valluri (2020). Design and Implementation of Pesticide Spraying Robot using IOT. *International Journal of Advance Research and Innovation*. 8(2), 148-151.
- [14] Julien Dougoud, Stefan Toepfer, Melanie Bateman & Wade H. Jenner (2019). Efficacy of homemade botanical insecticides based on traditional knowledge. A review. *Agronomy for Sustainable Development*. 39:37. <https://doi.org/10.1007/s13593-019-0583-1>
- [15] Tembo Y., Mkindi A.G., Mkenda P.A., Mpumi N., Mwanauta R., Stevenson P.C., Ndakidemi P.A. & Belmain S.R. (2018). Pesticidal plant extract improve yield and reduce insect pests on Legume crops without harming beneficial arthropods. *Frontiers in Plant Science*. 9:1425. <https://doi.org/10.3389/fpls.2018.01425>

- [16] Toheed Iqbal, Nazeer Ahmed, Kiran Shahjeer, Saeed Ahmed, Khalid Awadh Al-Mutairi, Hanem Fathy Khater & Reham Fathey Ali (2021). Botanical insecticides and their potential as anti-insect/pests: Are they successful against insects and pests?. *Global Decline of Insects*. <https://doi.org/10.5772/intechopen.100418>
- [17] Kaputa Fatima, Tembo Lovejoy & Kurangwa Wisdom (2019). Efficacy of Garlic (*Allium sativum*) and Red Chilli Pepper (*Capsicum annum*) Extracts in the control of Red Spider Mite (*Tetranychus urticae*) in Tomatoes (*Lycopersicon esculentum*). *American Journal of Applied Sciences*. 10(2).
- [18] Nguyen Minh Tuan, Bui Lan Anh & Bui Nu Hoang Anh (2014). Efficacy of Garlic and Chilli combination solution on cabbage insect pests and crop growth in Vietnam. *International Journal of Agricultural and Biosystems Engineering*. 8(10), 1146-1149. <https://doi.org/10.5281/zenodo.1096944>
- [19] R. Dewi, N. Hastuti & Y. Nuraeni (2020). Utilization of wood vinegar as plant-based insecticide in mulberry (*Morus* sp). *IOP Conference Series: Materials Science and Engineering*. 935:012027. <https://doi.org/10.1088/1757-899X/935/1/012027>