

Study of Multiwavelength Fiber Laser in a Highly Nonlinear Fiber

I. H. M. Nadzar¹ and N. A. Awang^{1*}

¹Faculty of Science, Technology and Human Development, Universiti Tun Hussein Onn Malaysia, Johor, Malaysia

Abstract: A multiwavelength fiber laser in linear and ring cavity have been successfully developed and demonstrated in numerical and experimental method. The multiwavelength fiber laser developed is incorporating with the nonlinearity of a short section of highly nonlinear fiber (HNLF) in order to suppress the homogeneous broadening effect of erbium-doped fiber amplifier (EDFA) within the gain medium. The performance aspects such as maximum number of lasing lines generated, maximum output power produced, wavelength span covered, maximum gain obtained, and signal-to-noise ratio have been successfully investigated and analysed. The linear cavity fiber laser is observed to have more number of lasing lines generated with higher output power and wider span of wavelength when compared to ring cavity fiber laser. The output spectrum from experimental method seems to have greater performance than numerical method where 11 lasing lines in the range from 1586 nm to 1596 nm with highest output power -22.40 dBm and SNR of 43 dB is obtained for experimental method while only 4 lines generated in 1595 nm to 1594 nm wavelength range with highest output power of 0.18 dBm and SNR of 75.42 dB.

Keyword: Multiwavelength fiber laser, erbium-doped fiber amplifier (EDFA), highly nonlinear fiber (HNLF)

1. Introduction

Due to the evolution of triple-play communication system, there is a splendid growth of internet and data traffic. Therefore, huge bandwidth or transmission capacity is demanded in telecommunication field to keep a good momentum with the growth of broad communication system [1]. Through development of wavelength division multiplexing system, a broad transmission capacity up to TB/s could be achieved. Unfortunately, as the number of channels demanded in the system increase, the number of light sources also increases and this arising the cost and complexity of the system. For this reason, a multiwavelength fiber laser technology is beneficial in acting as a single gain medium of light source that can provide several number of channels simultaneously [2]. A multiwavelength fiber laser with erbium-doped fiber amplifier as the gain medium gives a challenge to researchers in developing and demonstrating it due to its homogeneous broadening behaviour in room temperature which causes all atoms to have the same gain spectrum and emerge a mode competition among the wavelengths whereby dominant wavelength will suppress other wavelengths and hence preventing the desired multiple wavelength output [3-4].

An approach was presented in 1996 by implementing the technique of cooling the erbium-doped fiber (EDF) to 77K with liquid nitrogen that resulted as the linewidth of the erbium-doped fiber amplifier (EDFA) became narrowed and 11 stable lasing lines were produced with 0.65 nm channel spacing [5]. Although this approach worked it is judged for being impractical for many practical applications [6]. In this paper, a multiwavelength fiber laser incorporating with the nonlinearity of a highly nonlinear fiber (HNLF) is proposed and successfully demonstrated. The multiwavelength fiber laser is demonstrated using both types of laser cavity; linear cavity and ring cavity, in both numerical and experimental method. The performance aspects considered for all configurations developed are the maximum number of lasing lines generated, highest output power produced, span of wavelength, gain, and signal-to-noise ratio (SNR).

2. Experimental Setup

The configuration for linear cavity fiber laser in experimental and simulation is shown in Figure 1. The simulation used in this project is Optisystem software version 7.0.

*Corresponding author: norazura@uthm.edu.my
2016 UTHM Publisher. All right reserved.
penerbit.uthm.edu.my/ojs/index.php/jst

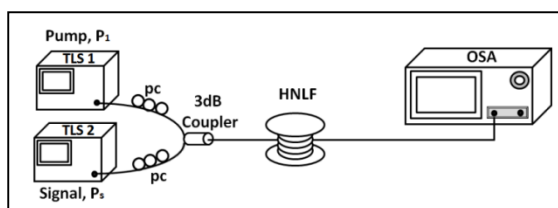

(a)

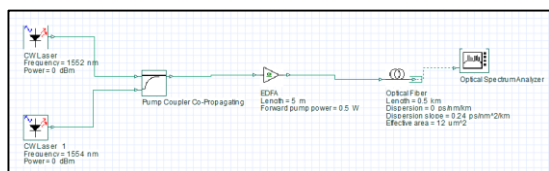

(b)

Figure 1 Linear cavity of multiwavelength fiber laser for (a) Experimental setup (b) Simulation setup by using Optisym.

In the setup, two Yokogawa (AQ2200) Tunable Laser Sources (designated TLS1 and TLS2); with wavelength of 1552 nm 1554 nm and linewidths of 0.015 nm are used as signal, P_s and pump, P_1 sources. Both P_1 and P_s are combined using a 3 dB coupler and a Polarization Controller (PC) to adjust the polarization of the input signals in order to obtain the maximum FWM efficiency. The HNLF used in this experiment is from OFS with specifications of the nominal ZDW, loss coefficient, dispersion slope and nonlinear parameter of 1531 nm, 0.73 dB/km, 0.007 ps/nm².km and 10.8 (W.km)⁻¹, respectively. A Yokogawa Optical Spectrum Analyzer (OSA) with 0.02 nm resolution bandwidth is used to measure the generated multiwavelength spectrum.

The configuration for ring cavity fiber laser in experimental and simulation is shown in Figure 2 and Figure 3. Most of the optical components used have the same parameter with the one used for linear cavity fiber laser. The signal to be amplified is generated by the EDF itself without any external input wavelength provided by TLS. The signal is allowed to oscillate in two direction; clockwise direction and anti-clockwise direction. An isolator is needed in ring cavity fiber laser to prevent any unwanted feedback. Another additional optical component is a transmission filter with center wavelength at 1550 nm and bandwidth of 1 nm.

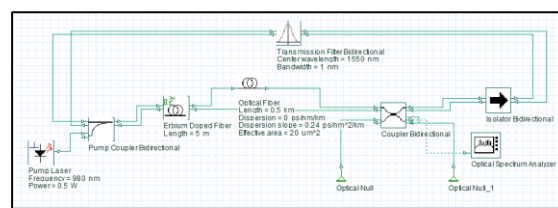

Figure 2 Simulation model for ring cavity multiwavelength fiber laser in numerical method.

Another ring cavity configuration is demonstrated experimentally. The schematic diagram is as shown in Figure 3. This configuration is also tested numerically to make a comparison for the output obtained from both methods. The EDF used as the gain medium has a length of 11 m with an erbium ion concentration of 900 ppm, and signal and pump absorption coefficients of 18.06 dBm⁻¹ and 8.30 dBm⁻¹ at 1530 nm and 1490 nm respectively. A pump source with 980 nm wavelength and threshold optical power of 40 mW is used to provide energy to EDF. The energy is absorbed by erbium ions in EDF to generate the broadband spontaneous emission.

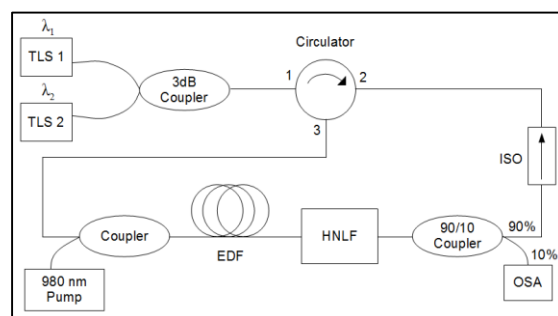

Figure 3 Schematic diagram for ring cavity multiwavelength fiber laser in experimental method.

Two tunable laser sources, TLS 1 and TLS 2, are used as the source of optical signals. Input wavelength from TLS 1 denoted as λ_1 is fixed at wavelength of 1590 nm with an average output power of 12.8 dBm while input wavelength from TLS 2 denoted as λ_2 is varied from 1570 nm to 1600 nm with an average output power of 10.8 dBm. Both input wavelengths are combined using a 2×1 3dB coupler which then connected to the port 1 of an optical circulator. The circulator routes the input wavelengths to the ring cavity through port 2. The reflected light propagates to port 3 of the circulator and is made to travel in anti-

clockwise direction. This dual-wavelength optical signal will undergoes an amplification done by EDF and then it will continue travels towards the short section HNLF. Within HNLF section, the signal will interact with the nonlinearity of HNLF and generate more wavelengths based on nonlinearity HNLF and FWM effect, as long as they are phase matched.

The HNLF used has a length of 100 m with zero-dispersion at 1550 nm, dispersion slope of $0.007 \text{ ps nm}^{-2} \text{ km}^{-1}$, loss coefficient of 0.73 dB km^{-1} , and nonlinear parameter of $10.8 \text{ W}^{-1} \text{ km}^{-1}$. An optical spectrum analyser is used to analyse the output spectrum from the end of 90/10 coupler with a resolution of 0.02. The 90/10 coupler means that 90% of the signal is feed back into the cavity while the other 10% is transmitted. To prevent unwanted feedback into the laser's cavity, an isolator is placed in the fiber laser's cavity.

3. Results And Discussions

The comparison between linear cavity and ring cavity configuration observed that for types of variation, the linear cavity gives better performance output than ring cavity. It is also observed that the number of lasing lines and output power increased with increment of power of TLS and pump power for both linear and ring cavity configurations. This could be due to the power given is absorbed by the erbium ion within EDFA to be used as energy to amplify the input signal. The EDFA gain more energy when the power given higher. But at certain point of variation given, the number of lasing lines and output power remained constant at maximum value or continuously decreased. This is the point where the EDFA is fully inverted and exhibit the maximum gain to amplify wavelengths or the EDFA has reached gain saturation for the decrement situation. While when the effective area of HNLF is varied with an increment, the number of lasing lines and output power seems to be decreased. This is because the nonlinearity of HNLF is dependent to its effective area. This phenomenon is according to the equation of nonlinear parameter of HNLF,

$$\gamma = \frac{n_2 \omega_0}{c A_{eff}} = \frac{n_2 2\pi}{\lambda A_{eff}}$$

where n_2 is the nonlinear-index coefficient which fixed for each glass material, λ is the wavelength of light, and A_{eff} is the effective mode area [7]. By increasing the effective area of HNLF, the nonlinearity of HNLF decreased and hence it reducing the effectiveness of HNLF in suppressing the homogeneous broadening effect within EDFA. Thus, less number of lasing lines will be generated with lower output power.

For experimental investigation using configuration in Figure 3, the multi-wavelength output was generated by the dual-wavelength oscillation locked by the dual-wavelength input that was initially amplified by EDF and then injected into the HNLF whereby its nonlinearity will helps in suppressing the homogeneous broadening effect of EDF. Figure 4 shows the results obtained in numerical method and experimental method by applying variation of pump power at 40 mW, 67 mW, 81 mW and 90 mW onto the configuration.

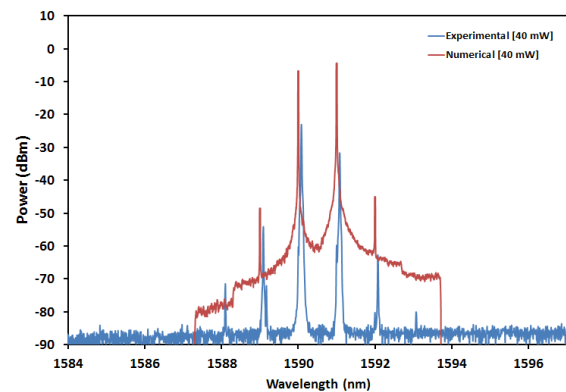

(a)

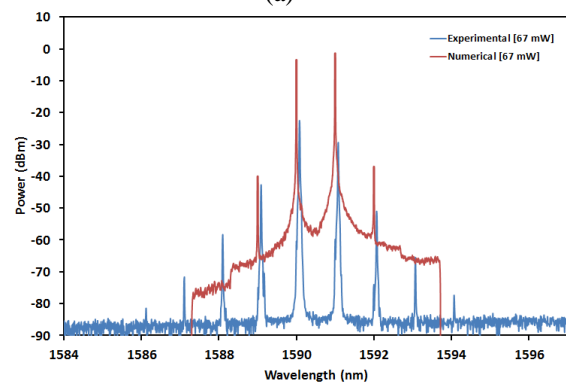

(b)

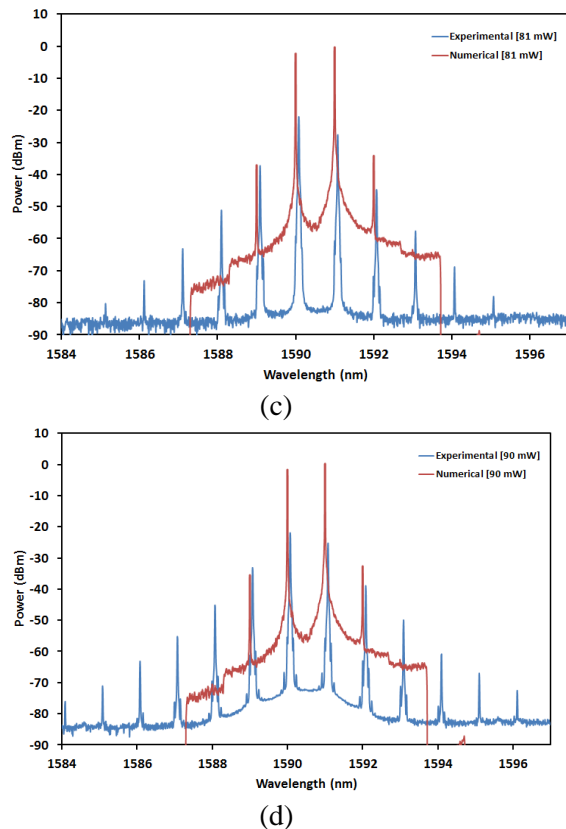

Figure 4 The output spectrum obtained from numerical method and experimental method a power of pump source of (a) 40 mW, (b) 67 mW, (c) 81 mW, and (d) 90 mW.

The input wavelength, λ_1 is fixed at 1590 nm while the input wavelength, λ_2 is fixed at 1592 nm. Both of the input wavelengths act as a dual-wavelength that lock-in a dual-wavelength oscillation in the laser's cavity in order to suppress any mode competition that arise from the homogeneous broadening effect of EDF.

The incidence of λ_1 and λ_2 produce a moving refractive index grating based on the FWM effect in the HNLF. It is modulated at wavelength of $\Delta\lambda = \lambda_1 - \lambda_2$. Hence, any signal propagating in HNLF at wavelength of λ will undergoes inelastic diffraction by a grating to generate new wavelengths of $\lambda \pm \Delta\lambda$ and as these signals travel in the HNLF, new wavelengths will be continuously generated by the general formula of $\lambda \pm n\Delta\lambda$ ($n = \pm 1, \pm 2, \dots \pm n$). In other words, the input signal wavelengths will be self-diffracted and will exhibit a number of sidebands at $\pm n\Delta\lambda$ on each side of input wavelengths in the output spectrum [8]. Hence, a multi-wavelength output is produced.

The numerical output spectrums have higher output power compared to experimental output spectrums but less number of lasing lines

generated. The highest output power obtained in numerical method is 0.18 dBm located at 1591 nm while in experimental method is -22.40 dBm located at 1590 nm with pump power of 90 mW. The number of lasing lines generated when pump power fixed at maximum value is 4 lines and 11 lines for numerical method and experimental method respectively. Each of the lasing lines produced have output power more than -70 dBm. The SNR recorded for numerical method and experimental method is 75.42 dB and 43 dB respectively.

For experimental method, another investigation is made by observing the effect of variation of input wavelength, λ_2 from TLS 2 on the number of lasing lines generated at different pump power. In this investigation, input wavelength, λ_1 is fixed at 1590 nm. From Figure 5, it is observed that number of wavelengths or lasing lines remained constant at the highest number for wavelength range from 1582 nm to 1600 nm. This phenomenon is due to the gain profile of EDF is consistent in the wavelength range of 1582 nm to 1600 nm. It is also observed that the number of lasing lines generated increased as the power of pump source increased. At pump power of 40 mW, there are only 4 lines generated. As the pump power increased to 67 mW and 81 mW, the number of lasing lines generated is 8 lines and 9 lines respectively. At the maximum pump power, 90 mW, the number of lasing lines generated is 11 lines. The number of lasing lines increased as pump power increased is due to increment of gain energy absorbed by the erbium ion within the EDF and therefore, able to generate more lasing lines at higher pump power.

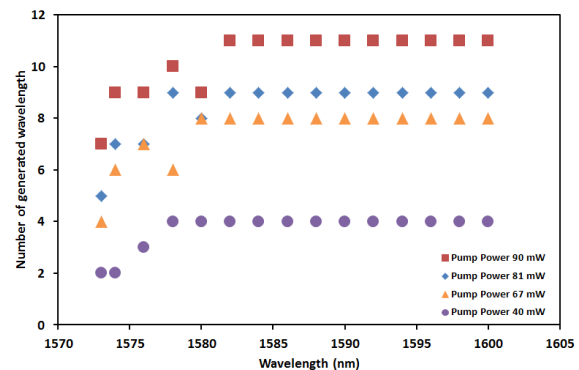

Figure 5 Number of lasing lines generated versus variation of input wavelength, λ_2 at different pump power.

4. Conclusion

A multiwavelength fiber laser incorporating with a highly nonlinear fiber has been successfully demonstrated using both linear cavity and ring cavity configurations. From the simulation made for both types of laser cavity, it can be concluded that the linear cavity multiwavelength fiber laser generates more number of lasing lines than ring cavity fiber laser with much higher output power and wider span of wavelength. Another conclusion is made for output obtained from numerical method and experimental method over the same ring cavity configuration. The numerical method gives an output spectrum that covers a wavelength range from 1585 nm to 1594 nm with highest generated lasing lines of 4 lines, highest output power of 0.18 dB and SNR of 75.42 dB. While the output spectrum obtained from experimental method has a wavelength span of 1584 nm to 1597 nm, highest number of lasing lines generated of 11 lines, highest output power of -22.40 dBm, and SNR of 43 dB. It can be concluded that the experimental method gives output spectrum with greater performance than numerical method.

Acknowledgements

The authors would like to express their gratitude to the research acculturation grant scheme (RAGS) under grant no. R042 by the University Tun Hussein Onn Malaysia, by the Ministry of Education, Malaysia.

References

- [1] The Applied Technologies Group, (1997). Dense Wavelength Division Multiplexing, One Apple Hill.
- [2] K. K. Qureshi, (2006). "Fiber ring lasers and all-optical signal processing devices for wavelength division multiplexing systems," Ph.D. dissertations, Department Electronic Engineering, Hong Kong Polytechnic University.
- [3] B. Lee and I. Yoon, (2007). "Multiwavelength optical fiber lasers and semiconductor optical amplifier," in *Optical Fiber Research Advances*, New York: Nova Science Publishers, ch. 13, pp. 335-353.
- [4] N. A. Awang, M. Z. Zulkifli, A. A. Latif, S. W. Harun and H. Ahmad, (2011). "Stable power multi-wavelength fibre laser based on four-wave mixing in a short length of highly nonlinear fibre," *Journal of Optics*, IOP publishing.
- [5] J. Chow, G. Town, B. Eggleton, M. Ibsen, K. Sudgen, and I. Bennion, (1996) "Multiwavelength generation in an erbium-doped fiber laser using in-fiber comb filters," *IEEE Photonics Technology Letters*, vol. 8, pp. 60-62.
- [6] S. Pan, C. Lou, and Y. Gao, (2006). "Multiwavelength erbium-doped fiber laser based on inhomogeneous loss mechanism by use of a highly nonlinear fiber and a Fabry-Perot filter," *Optics Express*, vol. 14, no. 3.
- [7] G. P. Agrawal, (2007). "Highly nonlinear fibers," in *Nonlinear Fiber Optics*, California: Academic Press, ch. 11, pp. 424-449.
- [8] N. A. Awang, (2012). "Study of four wave mixing in a highly nonlinear media and their applications," Ph.D. dissertations, Universiti Malaya.